

SOLID

a
major
resto-
ration

for the
master-
piece
human



Diagnostics



Buck
SLD-01-101-18
Percussion Hammer
18.5 cm,



Buck
SLD-01-102-18
Percussion Hammer
20cm,

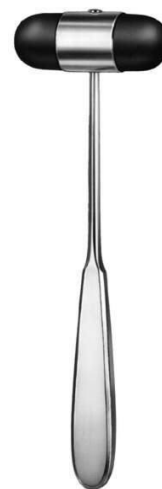

Dejerine
SLD-01-103-20
Percussion Hammer
20cm,



Dejerine
SLD-01-104-21
Percussion Hammer
21cm,



Taylor Mod. USA
SLD-01-105-20
Percussion Hammer
20cm,



Wartenberg
SLD-01-106-19
Pinwheel
18cm,



Pinard
SLD-01-107-18
Stethoscope
18 cm,



Pinard
SLD-01-108-15
Stethoscope
15cm,



Magill

SLD-02-101-15

Catheter Introducing Forceps
14.5 cm, 20 cm, 25 cm,



Miller

SLD-02-102-00

Laryngoscope Sets



Miller-Baby

SLD-02-103-00

Laryngoscope Sets



Miller

SLD-02-104-00

Laryngoscope Blade
Fig. 0, Fig. 1, Fig. 2, Fig. 3, Fig. 4,



Guedel-Negus

SLD-02-105-00

Laryngoscope Sets
Fig. 2, Fig. 3, Fig. 4,



Guedel-Negus

SLD-02-106-00

Laryngoscope Sets
Fig. 1, Fig. 2, Fig. 3, Fig. 4,



Guedel-Negus
SLD-02-107-01

Laryngoscope Blades
Fig. 1, Fig. 2, Fig. 3, Fig. 4,



McIntosh
SLD-02-108-00



McIntosh
SLD-02-109-00
Laryngoscope Blades
Fig. 0, Fig. 1, Fig. 2, Fig. 3, Fig. 4,



McIntosh
SLD-02-110-00

Laryngoscope Sets
Fig. 1, Fig. 2, Fig. 3, Fig. 4,



Foregger
SLD-02-111-01
Laryngoscope Blades
Fig. 1, Fig. 2, Fig. 3, Fig. 4,



Battery Handle
SLD-02-112-00
Battery Handle



McIntosh

SLD-02-114-00

Laryngoscope Sets fiber optic
Fig. 1, Fig. 2, Fig. 3,



McIntosh

SLD-02-115-00

Laryngoscope Sets fiber optic
Fig. 1, Fig. 2, Fig. 3,



McIntosh

SLD-02-116-00

Laryngoscope Sets fiber optic
Fig. 1, Fig. 2, Fig. 3,



McIntosh

SLD-02-113-00

Laryngoscope Sets
Fig. 1, Fig. 2, Fig. 3, Fig. 4,

Trocars



Universal
SLD-03-101-04
Trocar
14 cm,



Nelson
SLD-03-102-07
Trocar
20 cm,



Lichtwitz
SLD-03-103-19
Antrum Trocar
18.5 cm,



Adson
SLD-03-104-21
Suction Cannula
20 cm,



Frazier
SLD-03-105-10
Suction Cannula
24 cm,



Frazier
SLD-03-106-06
Suction Cannula
19.5 cm,

Trocars



Poppen
SLD-03-107-06
Suction Cannula
18 cm,



Luer
SLD-03-108-30
Suction Tube working length 110 mm



Yasargil
SLD-03-109-15
Suction Tube working length 150 mm with
Luer hub
21.5 cm,



Yankauer
SLD-03-110-27
Suction Tube complete with suction tip and
connector
31 cm,



Yankauer
SLD-03-111-00
Suction Tube
31 cm, 15 cm, 2.5 cm, 10 cm,



Poole
SLD-03-112-22
Suction Tube
22 cm,

Trocars



Poole
SLD-03-113-22
Suction Tube
22.5 cm,



Nuboer
SLD-03-114-21
Suction Tube
21 cm,



Nuboer
SLD-03-115-21
Suction Tube
21 cm,



Quinke
SLD-03-116-10
Lumbar Puncture Needle



Tuohy
SLD-03-117-12
Lumbar Puncture Needle Luer Lock
connection with special tip



Verres
SLD-03-118-20
Insufflation Cannula Luer Lock connection
15 cm,



Verres

SLD-03-119-20

Insufflation Cannula Luer Lock connection
17 cm,



Kalt
SLD-04-105-14
 Needle Holder
 13.5 cm,



Barraquer-Troutman
SLD-04-106-10
 Micro Needle Holder
 10 cm, 10.5 cm,



Arruga
SLD-04-107-14
 Micro Needle Holder
 13.5 cm,



Barraquer-Troutman
SLD-04-108-10
 Micro Needle Holder
 10.5 cm, 11.5 cm,



Barraquer
SLD-04-109-11
 Micro Needle Holder
 11.5 cm, 13.5 cm, 14 cm,



Barraquer
SLD-04-110-13
 Micro Needle Holder
 13.5 cm,



Castroviejo-Fino
SLD-04-111-01
Micro Needle Holder
13 cm,



Castroviejo-Fino
SLD-04-112-01
Micro Needle Holder
13 cm,



Castroviejo-Fino
SLD-04-113-01
very delicate jaw with lock
13 cm,



Castroviejo
SLD-04-114-14
Micro Needle Holder with lock
14 cm,



Castroviejo
SLD-04-115-14
Micro Needle Holder
14 cm,



Castroviejo
SLD-04-121-14
Micro Needle Holder with lock
14 cm,



Castroviejo
SLD-04-122-14
Micro Needle Holder
14 cm,



Castroviejo
SLD-04-124-13
Micro Needle Holder with lock
12 cm,

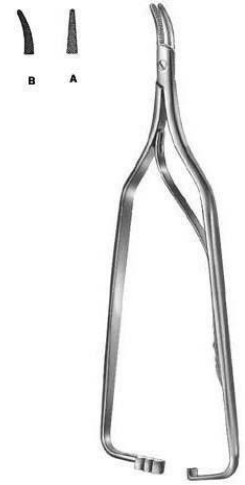

Arruga
SLD-04-123-16
Needle Holder delicate
16 cm,



Castroviejo
SLD-04-125-12
Micro Needle Holder with lock
12 cm,



Derf
SLD-04-126-12
Needle Holder
12 cm, 13 cm,

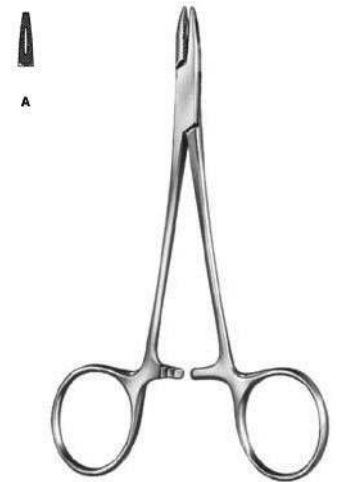

Collier
SLD-04-127-12
Needle Holder
12.5 cm,



Webster
SLD-04-128-13
 Needle Holder
 cm,

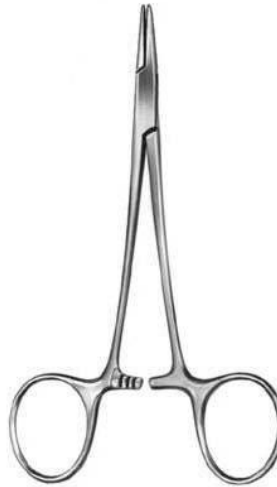

Halsey
SLD-04-129-13
 Needle Holder
 13.5 cm,



Neivert
SLD-04-130-13
 Needle Holder
 12.5 cm,

13



Hegar-Baumgartner
SLD-04-131-14
 Needle Holder
 14.5 cm,



Crile-Murray
SLD-04-133-15
 Needle Holder
 15 cm,



Crile-Wood
SLD-04-134-15
 Needle Holder
 15 cm,



Adson

SLD-04-140-18

Needle Holder one fenestrated jaw
18 cm,



Metzenbaum

SLD-04-141-18

Needle Holder one grooved and fenestrated
jaw
18.5 cm,



M. G. Hospital

SLD-04-142-17

Needle Holder
17.5 cm,

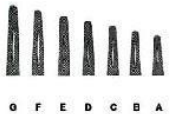

Mayo-Hegar

SLD-04-143-14

Needle Holder

14.5 cm, 16 cm, 18.5 cm, 20.5 cm, 24 cm, 26.5
cm,



Mayo-Hegar

SLD-04-144-16

Needle Holder

16 cm, 18.5 cm, 20.5 cm,



Brown

SLD-04-145-13

Needle Holder

13 cm, 18 cm,

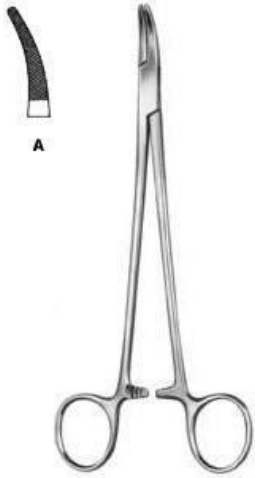

Heaney
SLD-04-146-21
Needle Holder
20.5 cm,

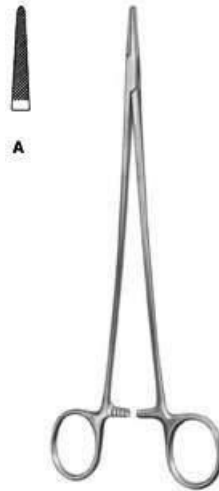

Jamison
SLD-04-147-23
Needle Holder
23.5 cm,



Masson
SLD-04-148-27
Needle Holder
26.5 cm,

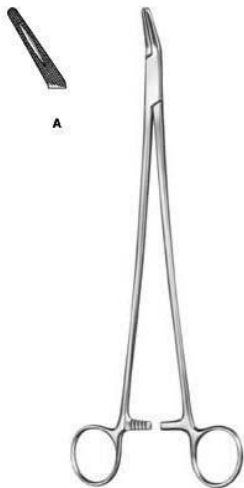

Finochietto
SLD-04-149-27
Needle Holder
26.5 cm,



Wangensteen
SLD-04-150-27
Needle Holder
26.5 cm,

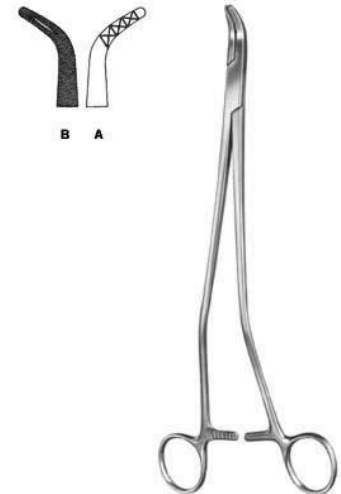

Johnson
SLD-04-151-27
Needle Holder
27 cm,

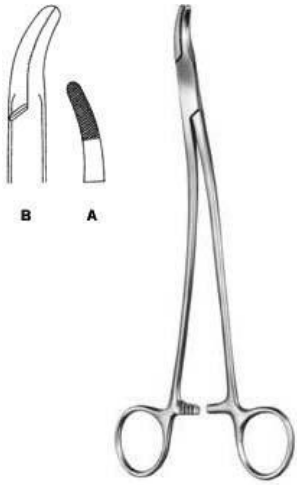

Stratte
SLD-04-152-23
 Needle Holder
 23 cm,

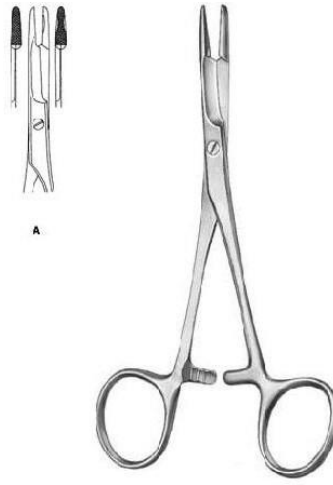

Olsen-Hegar
SLD-04-153-14
 Needle Holder
 14 cm,

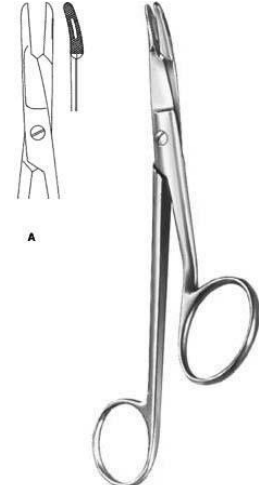

Gillies
SLD-04-154-16
 Needle Holder
 16 cm,



Crile
SLD-04-155-15
 Needle Holder
 15 cm,



Mathieu
SLD-04-156-14
 Needle Holder
 14 cm, 17 cm, 20 cm,



Mathieu
SLD-04-157-14
 Needle Holder
 14 cm, 16.5 cm,



Toennis
SLD-04-158-18
 Needle Holder
 18.5 cm,



Lichtenberg
SLD-04-159-20
 Needle Holder
 20 cm,



SLD-04-160-16
 Micro Needle Holder
 16 cm,

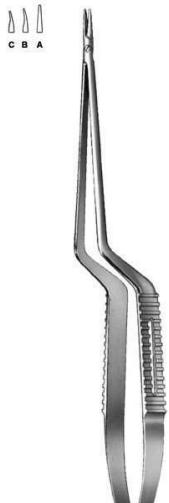

SLD-04-161
 Micro Needle Holder
 23 cm, 19 cm,



Hepp-Scheidel
SLD-04-162-18
 Micro Needle Holder smooth jaw
 18 cm,

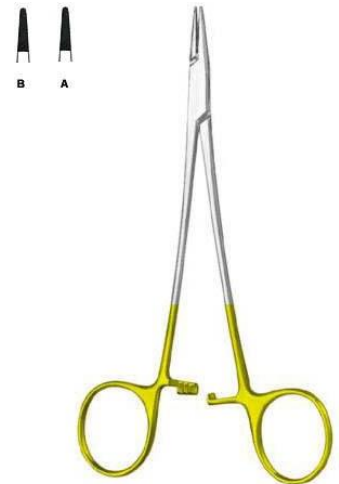

Webster
SLD-04-163-13
 Needle Holder with automatic release ratchet
 also for lefthanders
 13 cm, 15 cm,



SLD-04-164-15
Micro Needle Holder
15 cm, 18 cm, 21 cm, 23 cm,



JABOMA
SLD-04-165-18
Micro Needle Holder
18 cm,



Castroviejo
SLD-04-166
Micro Needle Holder
14.5 cm, 18 cm, 21.5 cm,



Arruga
SLD-04-167
Needle Holder
16 cm,



Castroviejo
SLD-04-168-13
Micro Needle Holder
12.5 cm,



Barraquer
SLD-04-169-13
Micro Needle Holder
13 cm,



Barraquer
SLD-04-170-13
 Micro Needle Holder
 13 cm,



Webster
SLD-04-171-13
 Needle Holder
 13 cm,



Derf
SLD-04-173-12
 Needle Holder
 12 cm,

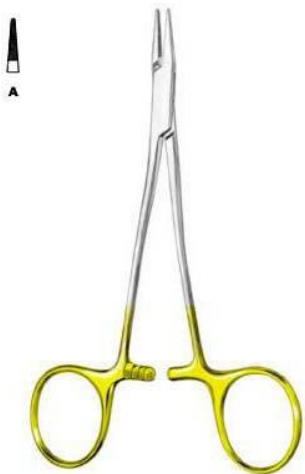

Kilner
SLD-04-172-13
 Needle Holder
 13 cm,



Hegar-Baumgartner
SLD-04-174-13
 Needle Holder
 13 cm, 14.5 cm,



Halsey
SLD-04-175-12
 Needle Holder
 13 cm, 12 cm,



Crile-Wood

SLD-04-176-15

Needle Holder
15 cm,



Sarot

SLD-04-177-18

Needle Holder
18 cm, 20 cm, 26 cm,

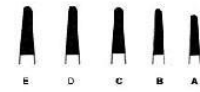

Mayo-Hegar

SLD-04-178-16

Needle Holder standard profile
16 cm, 18 cm, 20 cm, 24 cm, 26 cm, 30 cm,



Heaney

SLD-04-179-20

Needle Holder
20 cm, 24 cm, 26 cm,

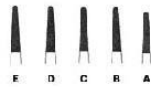

DeBakey

SLD-04-180-18

Needle Holder delicate pattern mini profile
18 cm, 20 cm, 23 cm, 26 cm, 31 cm,



Masson

SLD-04-181-27

Needle Holder
26.5 cm,

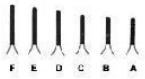

Ryder (Martin)

SLD-04-182-13

Needle Holder

12.5 cm, 15 cm, 18 cm, 20 cm, 23 cm, 26 cm,



Martin

SLD-04-183-15

Needle Holder mini profile elastic type
15 cm, 17 cm, 20 cm,



Wangensteen

SLD-04-184-27

Needle Holder standard profile
27 cm,



Hegar-Vascular

SLD-04-185-14

Needle Holder micro profile
14 cm, 18.5 cm, 20.5 cm, 23 cm,

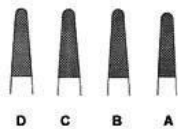

Bozemann

SLD-04-186-20

Needle Holder standard profile
20.5 cm, 24 cm, 26.5 cm, 29 cm,



Hegar

SLD-04-187-20

Needle Holder standard profile
20 cm, 23.5 cm,



Stratte

SLD-04-188-22

Needle Holder standard profile
23 cm,



Microvascular

SLD-04-189-00

Needle Holder slender pattern micro profile
14 cm, 17.5 cm, 20 cm, 23 cm,



Mathieu

SLD-04-190-14

Needle Holder
14 cm, 17 cm, 20 cm,



Mathieu

SLD-04-191-14

Needle Holder
14 cm, 17 cm, 20 cm,



Mathieu

SLD-04-192-17

Needle Holder standard profile with interior
ratchet
17 cm, 20 cm, 23 cm,



Toennis

SLD-04-193-18

Needle Holder
18.5 cm,



Lichtenberg
SLD-04-194-20

Needle Holder lightweight model standard profile
20 cm,



Langenbeck
SLD-04-195-18

Needle Holder
18 cm, 20.5 cm, 23 cm,



Zweifel
SLD-04-196-20

Needle Holder with hinged ratchet standard profile
20.5 cm, 23 cm,



Reverdin
SLD-04-197-15

Reverdin Needle short
14.5 cm Fig. 1, 14.5 cm Fig. 2, 14.5 cm Fig. 3, 14.5 cm Fig. 4,

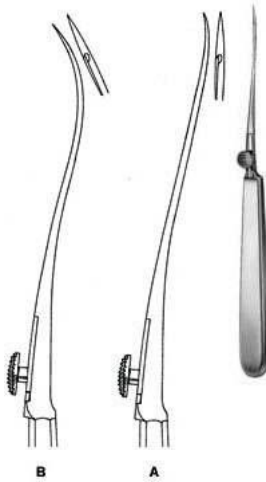

Reverdin
SLD-04-198-19

Reverdin Needle medium
19.5 cm Fig. 1, 19.5 cm Fig. 2, 19.5 cm Fig. 3, 19.5 cm Fig. 4,

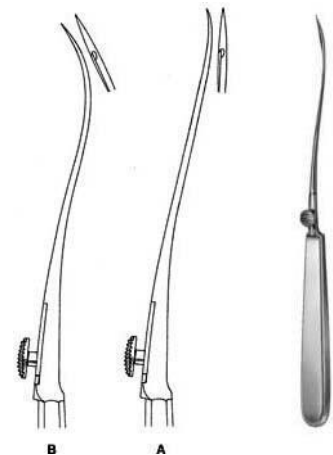

Reverdin
SLD-04-199-23

Reverdin Needle long
23 cm Fig. 1, 23 cm Fig. 2, 23 cm Fig. 3, 23 cm Fig. 4,

Suture

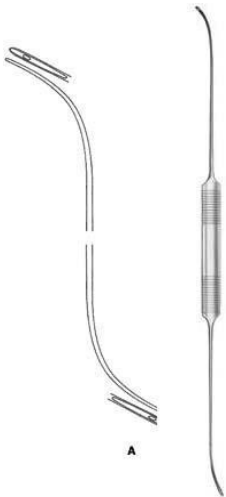

Schmieden-Dick
SLD-04-201-01
Ligature Needle malleable
29 cm,

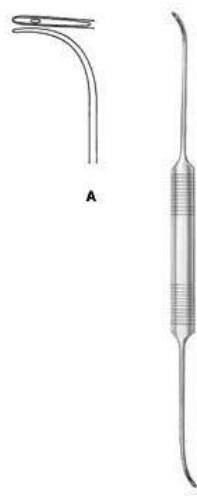

Schmieden
SLD-04-202-21
Ligature Needle
24 cm,



SLD-04-203-20
Ligature Needle malleable
20.5 cm,

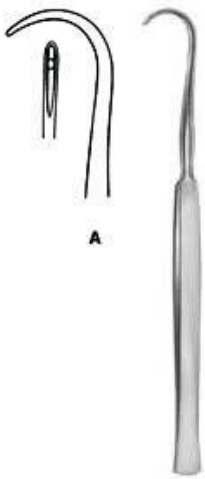

Cooper
SLD-04-204-19
Ligature Needle
18.5 cm,



Kronecker
SLD-04-205-13
Ligature Needle delicate for right hand
12.5 cm,

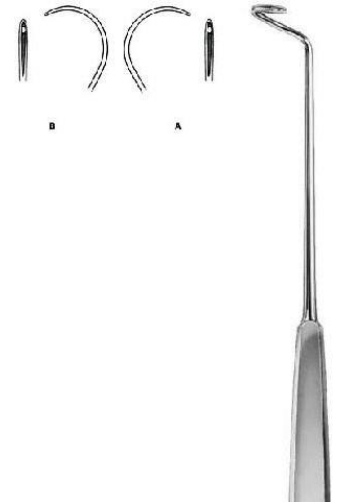

Deschamps
SLD-04-206-24
Ligature Needle blunt for right hand
24 cm,

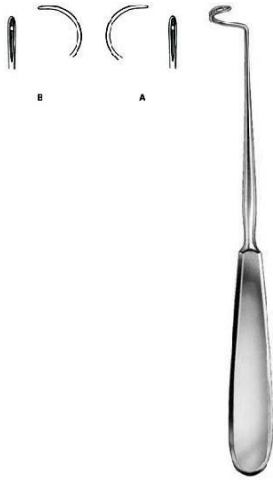

Deschamps

SLD-04-207-20

Ligature Needle blunt for right hand
20 cm,

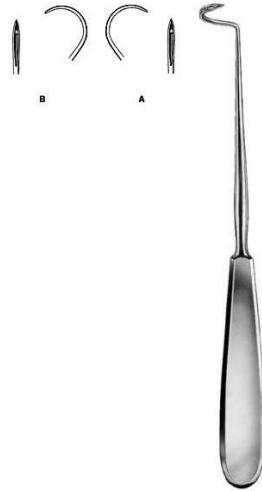

Deschamps

SLD-04-208-20

Ligature Needle sharp for right hand
20 cm,

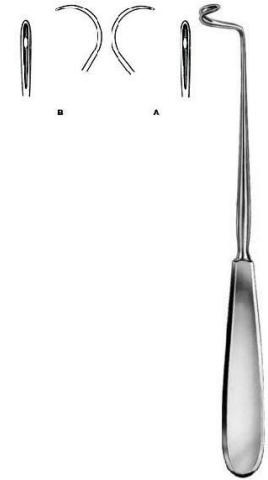

Deschamps

SLD-04-209-21

Ligature Needle blunt for right hand
20 cm,

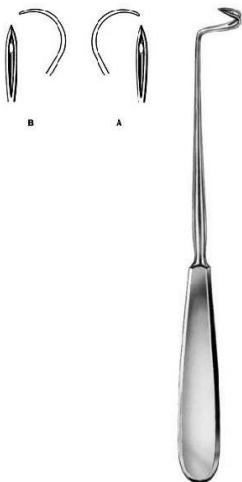

Deschamps

SLD-04-210-21

Ligature Needle sharp for right hand
20 cm,

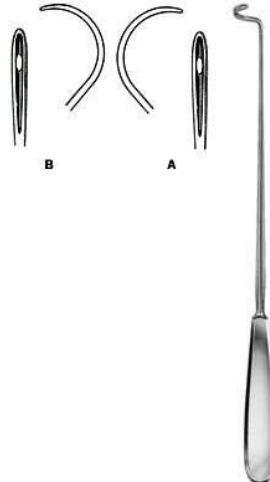

Deschamps

SLD-04-211-27

Ligature Needle blunt for right hand
27 cm,

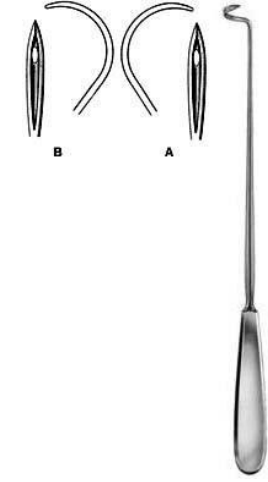

Deschamps

SLD-04-212-27

Ligature Needle sharp for right hand
27 cm,

Suture

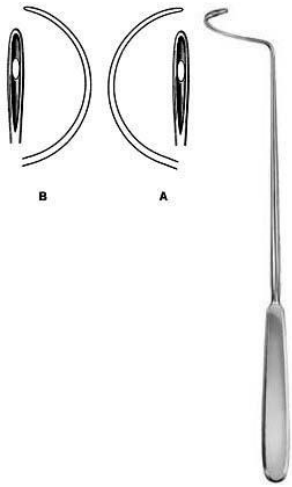

Deschamps
SLD-04-213-28

Ligature Needle blunt for right hand
28 cm,

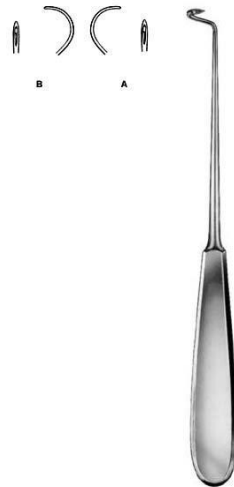

Deschamps
SLD-04-214-20

Ligature Needle sharp for right hand
20 cm,



Deschamps
SLD-04-215-20

Ligature Needle blunt for right hand
20 cm,



Deschamps
SLD-04-216-20

Ligature Needle blunt for right hand
21 cm,

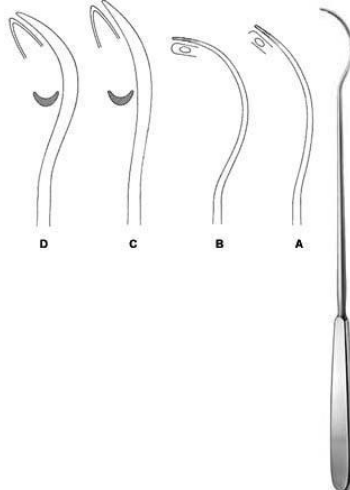

Brunner
SLD-04-217-30

Ligature Needle
21 cm,



Kirschner
SLD-04-218-25

Ligature Conductor
25.5 cm,

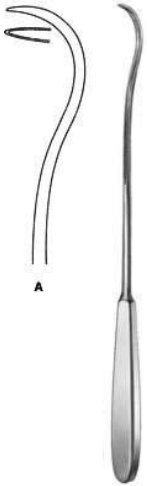

SLD-04-219-28
Ligature Conductor
28 cm,



Modell Wien
SLD-04-220-23
Ligature Catcher
23.5 cm,



Michel
SLD-04-221-12
Clip Applying Forceps
12 cm,



Hegenbarth
SLD-04-222-12
Clip Applying Forceps
12 cm,

Scalpels



SLD-05-101-01

Dissecting Knife with metal handle
15 cm, 15.5 cm, 16 cm, 17 cm,



SLD-05-102-10

Autopsy Knife
25.5 cm,

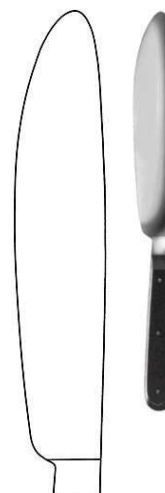

Walb

SLD-05-104-17
Post Mortem Knife

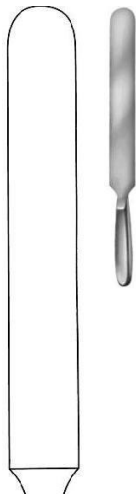

Virchow

SLD-05-105-20
Brain Knife with hollow handle
28.5 cm, 33.5 cm, 38 cm,



SLD-05-108-04

Scalpel Handle solid
13.5 cm,



SLD-05-109-34

Scalpel Handle
16 cm,

Scalpels



SLD-05-110-41
Scalpel Handle solid, long
21 cm,



SLD-05-111-45
Scalpel Handle
21 cm,



Collin
SLD-05-112-08
Scalpel Handle with hollow handle
13.5 cm,



Collin
SLD-05-113-09
Scalpel Handle with hollow handle
14.5 cm,



SLD-05-114-03
Scalpel Handle solid
12 cm,



SLD-05-115-04
Scalpel Handle
12 cm,

Scalpels



SLD-05-116-05
Scalpel Handle
12 cm,



SLD-05-117-31
Scalpel Handle solid, long
21.5 cm,



SLD-05-118-35
Scalpel Handle
21 cm,



SLD-05-119-07
Scalpel Handle solid
16 cm,



SLD-05-120-71
Scalpel Handle solid short
12.5 cm,



SLD-05-121-03
Scalpel Handle with round hollow handle
15.5 cm,

Scalpels



SLD-05-127-16

Amputation Knife with hollow handle
29 cm,



SLD-05-128-19

Amputation Knife with hollow handle
32.5 cm,



Catlin

SLD-05-129-16

Interosseous Knife with hollow handle
29cm,



SLD-05-130-06

Resection Knife solid handle, dissecting end
18 cm,



Langenbeck

SLD-05-131-05

Resection Knife
18 cm,



Langenbeck

SLD-05-132-05

Resection Knife
18 cm,

Scalpels



SLD-05-133-00

Razor Knife hollow blades on both sides
cutting length 75mm



Schink

SLD-05-134-00

Dermatome complete with 2 skin fixing plates
and one blade
31 cm,



Schink

SLD-05-135-01

Spare Blade spare blade for KE-05-134-00



Schink

SLD-05-136-02

Skin Fixing Plate for KE-05-134-00

Scissors



Standard BL / BL Straight

SLD-05-201-13

Operating Scissor Special Price: \$1.25
12 cm, 13 cm, 14.5 cm, 16.5 cm, 18.5 cm, 20.5 cm,



Standard SH / BL STR

SLD-05-202-13

Operating Scissors
12 cm, 13 cm, 14.5 cm, 16.5 cm, 18.5 cm, 20.5 cm,



Standard SH / SH STR

SLD-05-204-13

Operating Scissors
12 cm, 13 cm, 14.5 cm, 16.5 cm,



Standard BL / BL Curved

SLD-05-205-13

Operating Scissors
12 cm, 13 cm, 14.5 cm, 16.5 cm, 18.5 cm, 20.5 cm,



Standard SH / BL Curved

SLD-05-206-13

Operating Scissors
12 cm, 13 cm, 14.5 cm, 16.5 cm, 18.5 cm, 20.5 cm,



Standard SH / SH Curved

SLD-05-207-13

Operating Scissors
12 cm, 13 cm, 14.5 cm, 16.5 cm,

Scissors



Standard BL / BL Curved
SLD-05-208-14
 Operating Scissors delicate
 14.5 cm,



Incision Scissor
SLD-05-209-14
 Operating Scissor
 14.5 cm,



Deaver
SLD-05-210-14
 Operating Scissors



Mayo
SLD-05-211-15
 Dissecting Scissors
 14.5 cm, 15 cm, 17 cm, 23.5 cm, 14.5 cm, 15
 cm, 17 cm, 23.5 cm,



Mayo
SLD-05-212-23
 Dissecting Scissors
 23 cm, 22.5 cm, 28 cm,



Mayo-Harrington
SLD-05-213-22
 Dissecting Scissors
 23 cm, 22.5 cm, 28 cm,

Scissors

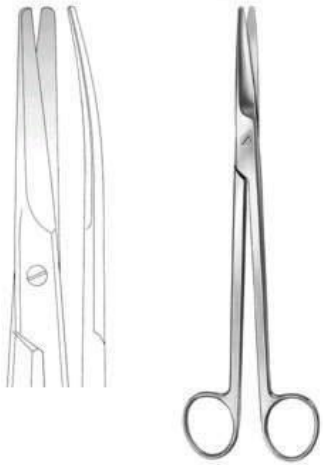

Mayo-Harrington
SLD-05-214-22

Dissecting Scissors cur.
22.5 cm, 28 cm, 23 cm,

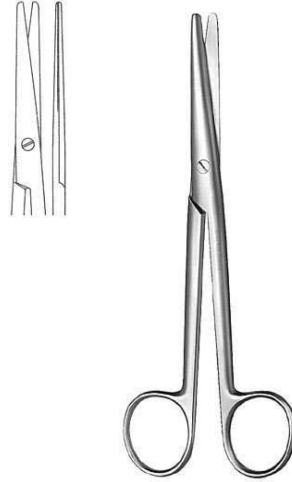

Mayo-Stille
SLD-05-215-17

Dissecting Scissors str.
15 cm, 17 cm,

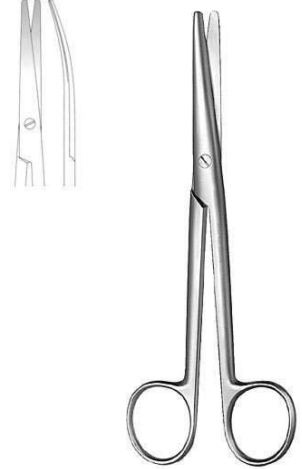

Mayo-Stille
SLD-05-216-15

Dissecting Scissors cur.
15 cm, 17 cm,

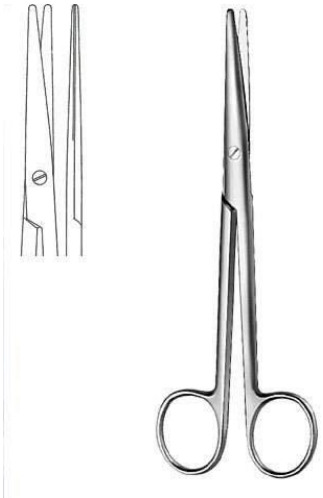

Mayo-Stille
SLD-05-217-19

Dissecting Scissors str.
16 cm, 19.5 cm, 21.5 cm,

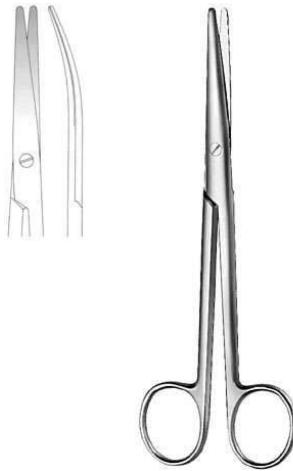

Mayo-Stille
SLD-05-218-16

Dissecting Scissors cur.
16 cm, 19.5 cm, 21.5 cm,



Mayo-Noble
SLD-05-219-17

Gynecological Scissors
16.5 cm,

Scissors

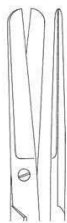

Sims

SLD-05-220-23

Gynecological Scissors str.
20 cm, 23 cm,



Sims

SLD-05-221-20

Gynecological Scissors cur.
20 cm, 23 cm,



Kelly

SLD-05-222-16

Operating Scissors
16 cm,



Doyen

SLD-05-223-17

Gynecological Scissors
18.5 cm,



Sims-Siebold

SLD-05-224-24

Gynecological Scissors
24.5 cm,



Sims-Siebold

SLD-05-225-24

Gynecological Scissors
24.5 cm,

Scissors



Wertheim
SLD-05-226-23
Gynecological Scissors
20 cm, 23 cm,



Metzenbaum
SLD-05-227-11
Dissecting Scissors
11.5 cm,



Metzenbaum
SLD-05-228-14
Dissecting Scissors
14.5 cm,



Metzenbaum
SLD-05-229-15
Dissecting Scissors
15.5 cm,



Metzenbaum-Nelson
SLD-05-230-20
Dissecting Scissors
18 cm, 20.5 cm, 23 cm, 26 cm, 28.5 cm, 31 cm,



Metzenbaum-Nelson
SLD-05-231-20
Dissecting Scissors
18 cm, 20.5 cm,

Scissors



Metzenbaum-Nelson

SLD-05-232-20

Dissecting Scissors

18 cm, 20.5 cm, 23 cm, 26 cm, 28.5 cm, 31 cm,



Metzenbaum

SLD-05-233-14

Dissecting Scissors toothed

14.5 cm,



Nerve Operating Scissor

SLD-05-234-15

Dissecting Scissors

15.5 cm,



Gorney

SLD-05-235-19

Face-lift Scissors str.

12.5 cm, 19.5 cm,

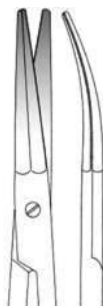

Gorney

SLD-05-236-19

Face-lift Scissors cur.

19.5 cm,



Aston

SLD-05-237-17

Face-lift Scissors

17 cm,

Scissors



Lexer
SLD-05-238-16
Dissecting Scissors
16 cm,

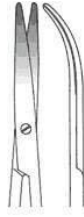

Cinelli
SLD-05-239-14
Nasal Scissors
11.5 cm, 14 cm,



Thorek
SLD-05-240-19
Dissecting Scissors
18.5 cm,



Lexer-Baby
SLD-05-241-10
Dissecting Scissors
10 cm,



Lexer-Fino
SLD-05-242-16
Delicate Dissecting Scissors slender pattern
16.5 cm,



Metzenbaum-Fino
SLD-05-243-14
Delicate Dissecting Scissors slender pattern
14.5 cm,

Scissors



Metzenbaum-Fino
SLD-05-244-14
 Delicate Dissecting Scissors
 14.5 cm,



Metzenbaum-Fino
SLD-05-245-14
 Delicate Dissecting Scissors
 14.5 cm,



Metzenbaum-Fino
SLD-05-246-14
 Delicate Dissecting Scissors
 14.5 cm,

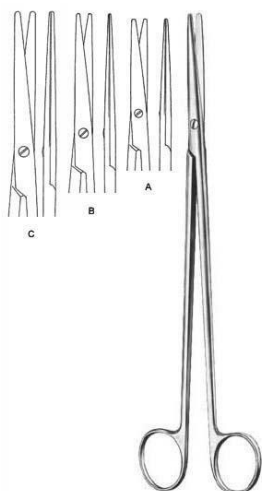

Metzenbaum-Fino
SLD-05-247-18
 Delicate Dissecting Scissors slender pattern
 18 cm, 20 cm, 23 cm,

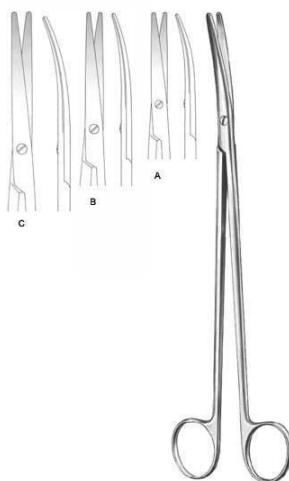

Metzenbaum-Fino
SLD-05-248-18
 Delicate Dissecting Scissors slender pattern
 18 cm, 20 cm, 23 cm,

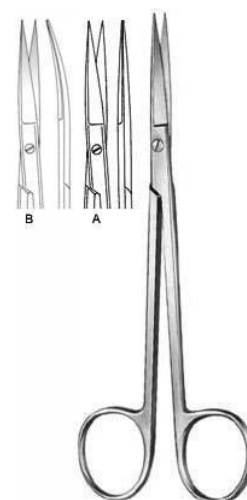

Sanvenero
SLD-05-250-14
 Operating Scissors
 14 cm,

Scissors

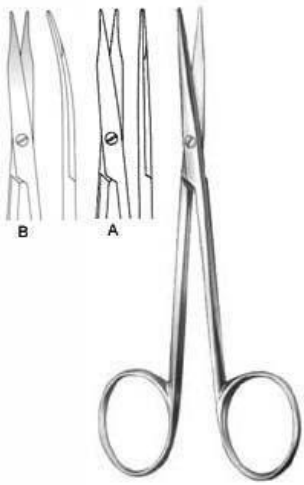

SLD-05-251-11
Fine Operating Scissors
11.5 cm,

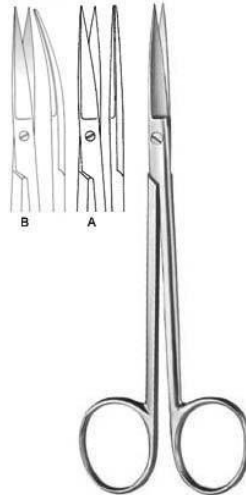

Joseph
SLD-05-252-14
Operating Scissors
14.5 cm,

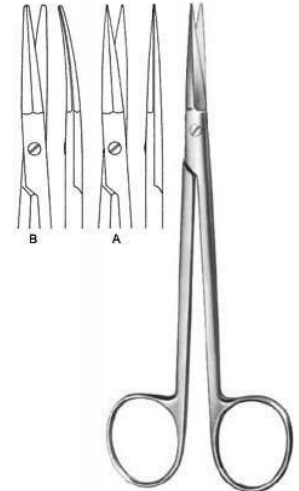

Peck-Joseph
SLD-05-253-14
Face-lift Scissors
14.5 cm,

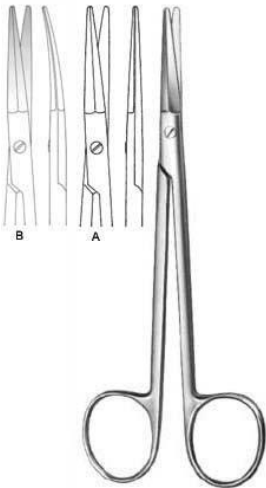

Peck-Joseph
SLD-05-254-14
Face-lift Scissors
14.5 cm,



Shea Vein Graft
SLD-05-255-12
Dissecting Scissors
12 cm,

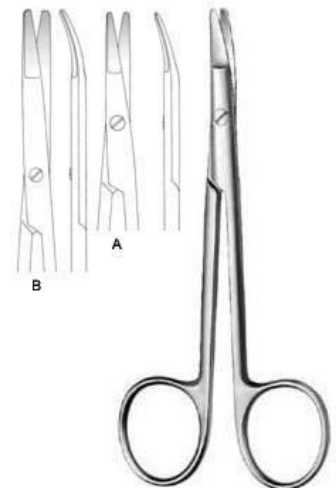

Kilner
SLD-05-256-12
Dissecting Scissors
12 cm, 15 cm,

Scissors

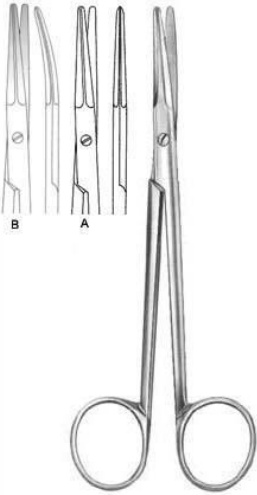

SLD-05-257-14
Dissecting Scissors
14.5 cm,

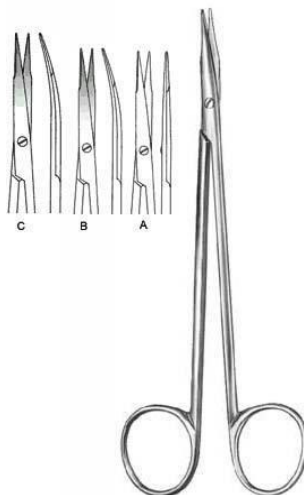

Reynolds
SLD-05-258-15
Dissecting Scissors
15.5 cm, 18 cm,



Jameson
SLD-05-259-14
Dissecting Scissors
15.5 cm,



Jameson
SLD-05-260-14
Dissecting Scissors
15.5 cm,



SLD-05-261-19
Vascular Scissors
19 cm,

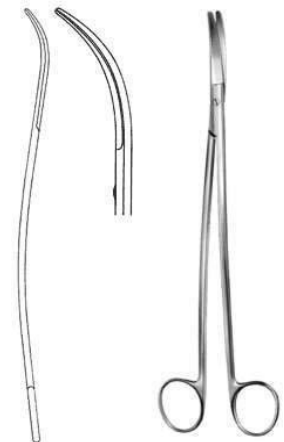

SLD-05-262-24
Vascular Scissors fine, short blades
19 cm, 25.5 cm,

Scissors

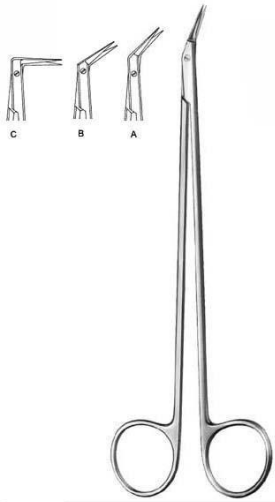

Diethrich

SLD-05-263-25

Vascular Scissors
19 cm, 18.5 cm, 17.5 cm,

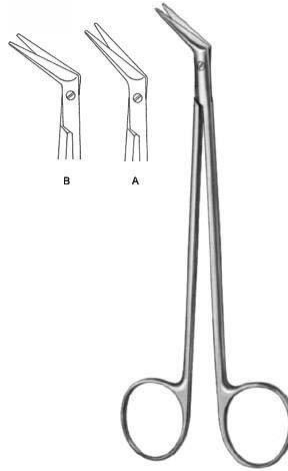

DeBakey

SLD-05-264-45

Vascular Scissors
16.5 cm, 16 cm,

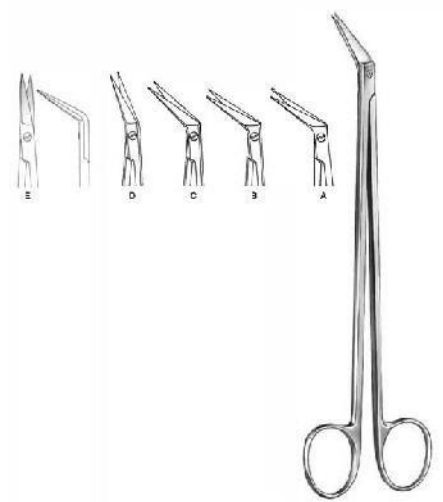

Potts-Smith

SLD-05-265-19

Vascular Scissors
18 cm, 18.5 cm, 19 cm,



Coronary Scissors

SLD-05-266-25

Cardiovascular Surgery Scissor
18 cm,



Coronary Scissors

SLD-05-267-45

Cardiovascular Surgery Scissors
18 cm,



Coronary Scissors

SLD-05-268-60

Cardiovascular Surgery Scissor
18 cm,

Scissors



Coronary Scissors

SLD-05-269-90

Cardiovascular Surgery Scissor
18 cm,



Coronary Scissors

SLD-05-270-00

Cardiovascular Surgery Scissor
18 cm,



Coronary Scissors

SLD-05-271-00

Cardiovascular Surgery Scissor
18 cm,



Coronary Scissors

SLD-05-272-25

Cardiovascular Surgery Scissor
18 cm,



Coronary Scissors

SLD-05-273-45

Cardiovascular Surgery Scissor
18 cm,



Coronary Scissors

SLD-05-274-90

Cardiovascular Surgery Scissor
18 cm,

Scissors



Schmieden-Taylor
SLD-05-275-17
Dura Scissors
15 cm,



Strully
SLD-05-276-22
Neurosurgical Scissors
22.5 cm,



Toennis-Adson
SLD-05-277-17
Dissecting Scissors
17.5 cm,



Good
SLD-05-279-19
Tonsil Scissors
19.5 cm,



Fomon
SLD-05-282-15
Nasal Scissors
15 cm,



Cottle
SLD-05-283-16
Nasal Scissors
16 cm,

Scissors



Heymann
SLD-05-284-18
Nasal Scissors
18.5 cm,



Heymann
SLD-05-285-18
Nasal Scissors
18.5 cm,



Converse
SLD-05-286-11
Nasal Scissors blunt & sharp
10.5 cm,



Waldmann
SLD-05-287-18
Episiotomy Scissors
18 cm,



Braun-Stadler
SLD-05-288-14
Episiotomy Scissors
14.5 cm,



Braun-Stadler
SLD-05-289-22
Episiotomy Scissors
22 cm,

Scissors



Modell USA
SLD-05-290-10
Umbilical Scissors
10.5 cm,



Busch
SLD-05-292-16
Umbilical Scissors
16 cm,



Goldmann-Fox
SLD-05-293-13
Gum Scissors
13 cm,



Wagner
SLD-05-294-12
Operating Scissors
12 cm,

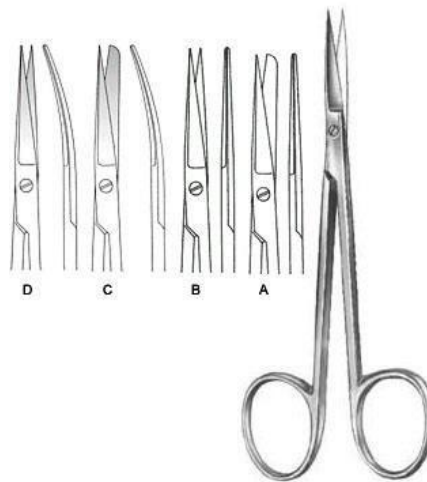

SLD-05-295-12
Operating Scissors small model
12 cm,



La Grange
SLD-05-296-11
Gum Scissors S-shaped
11.5 cm,

Scissors



SLD-05-297-11
Dissecting Scissors delicate
11.5 cm,



Locklin
SLD-05-298-16
Gum Scissors
16 cm,



Locklin
SLD-05-299-16
Gum Scissors
16 cm,



SLD-05-300-08
Operating Scissors very delicate
9 cm,

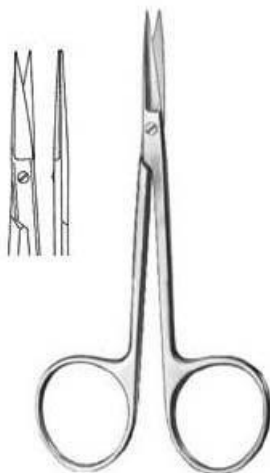

SLD-05-301-10
Iris Scissors
9 cm, 10 cm,

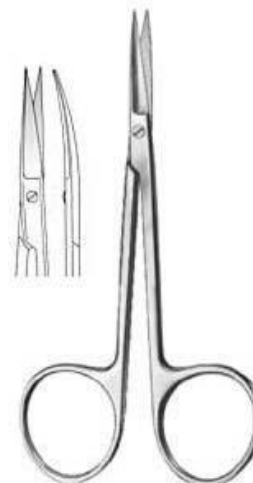

SLD-05-302-10
Iris Scissors extra flat blades
10 cm,

Scissors



SLD-05-303-10
Iris Scissors extra flat blades
10 cm,



Bonn
SLD-05-304-09
Iris Scissors



Dean
SLD-05-278-17
Tonsil Scissors
17.5 cm,



Spencer Scissor
SLD-

Dressing & Tissue Forceps



Standard

SLD-05-401-10

Dressing Forceps

10.5 cm, 11.5 cm, 13 cm, 14.5 cm, 16 cm, 18 cm, 20 cm, 23 cm, 25 cm, 30.5 cm,



Standard

SLD-05-402-11

Dressing Forceps

12 cm, 13 cm, 14.5 cm, 16 cm, 18 cm, 20 cm, 25 cm, 30 cm,



SLD-05-403-13

Dressing Forceps

13 cm, 14.5 cm,



Stille

SLD-05-404-15

Dressing Forceps

15 cm,



Mini-Adson

SLD-05-405-12

Dressing Forceps

12 cm,



Adson

SLD-05-406-12

Dressing Forceps

12 cm, 15 cm,

Dressing & Tissue Forceps



McIndoe
SLD-05-407-15
Dressing Forceps
15 cm,



Waugh
SLD-05-408-20
Dressing Forceps
20 cm,



Semken
SLD-05-409-12
Dressing Forceps
12.5 cm, 15 cm,



Taylor
SLD-05-410-17
Dressing Forceps
12.5 cm, 15 cm,



Taylor
SLD-05-411-17
Dressing Forceps
17 cm,



Taylor
SLD-05-412-17
Dressing Forceps
18.5 cm,

Dressing & Tissue Forceps



SLD-05-413-06
Micro Dressing Forceps
15.5 cm,



Gerald
SLD-05-414-18
Dressing Forceps
15.5 cm,



Cushing
SLD-05-415-17
Dressing Forceps
17.5 cm,



Potts-Smith
SLD-05-416-18
Dressing Forceps
18 cm, 21 cm, 24.5 cm,



Bonney
SLD-05-417-17
Dissecting Forceps
17.5 cm,



Gerald
SLD-05-418-17
Dissecting Forceps
17.5 cm,

Dressing & Tissue Forceps



Gillies
SLD-05-419-15
Dissecting Forceps
15.5 cm,



McIndoe
SLD-05-420-15
Dressing Forceps
15 cm,



Semken
SLD-05-421-16
Dissecting Forceps
15.5 cm, 17.5 cm,



Adson-Brown
SLD-05-422-12
Dissecting Forceps
12 cm,



Adson
SLD-05-423-12
Dissecting Forceps
12 cm, 15 cm,



Adson
SLD-05-424-12
Dressing Forceps
12 cm, 15 cm,

Dressing & Tissue Forceps



Cushing
SLD-05-425-17
Dressing Forceps
17.5 cm,



Cushing
SLD-05-426-18
Dressing Forceps
17 cm,



Cushing-Taylor
SLD-05-427-18
Dressing Forceps
18.5 cm,



Potts-Smith
SLD-05-428-15
Dressing Forceps
16 cm, 18.5 cm, 20 cm, 23 cm, 25 cm,



Oehler
SLD-05-429-14
Dissecting Forceps
14.5 cm, 16 cm, 18 cm, 20 cm, 25 cm,



Wangensteen
SLD-05-430-15
Dressing Forceps
15 cm, 23 cm,

Dressing & Tissue Forceps



DeBakey

SLD-05-431-15

Atraumatic Dressing Forceps

16 cm, 20 cm, 24.5 cm, 16 cm, 20 cm, 24.5 cm,



DeBakey

SLD-05-432-16

Atraumatic Dressing Forceps

16 cm, 20 cm, 24 cm,

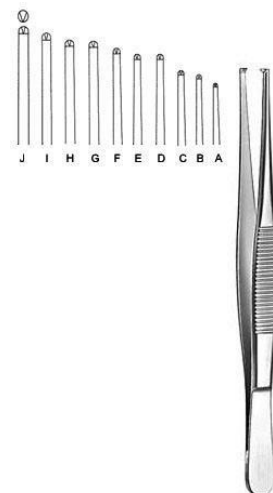

SLD-05-433-10

Dissecting Forceps

10.5 cm, 11.5 cm, 13 cm, 14.5 cm, 16 cm, 18 cm, 20 cm, 23 cm, 25 cm, 30.5 cm,

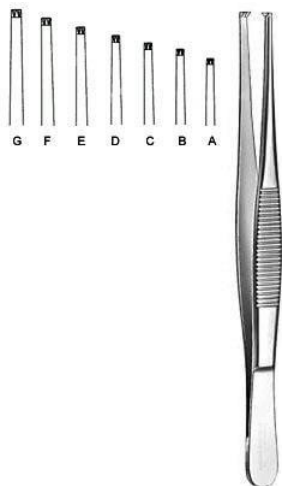

SLD-05-434-11

Dissecting Forceps

12 cm, 13 cm, 14.5 cm, 15.5 cm, 18 cm, 20 cm, 24.5 cm,



SLD-05-435-14

Dissecting Forceps

14.5 cm, 16 cm,



SLD-05-436-14

Dissecting Forceps

14.5 cm, 16 cm,

Dressing & Tissue Forceps



SLD-05-437-13
Dissecting Forceps
13 cm, 14.5 cm, 16 cm, 20 cm,



SLD-05-438-13
Dissecting Forceps
13 cm, 14.5 cm,



Stille
SLD-05-439-15
Dissecting Forceps
15 cm,



Stille
SLD-05-440-15
Dissecting Forceps
15 cm,



Stone
SLD-05-441-15
Dissecting Forceps
15 cm,



Lerche
SLD-05-442-15
Dissecting Forceps
15 cm,

Dressing & Tissue Forceps



Adlerkreutz

SLD-05-443-15

Dissecting Forceps
15.5 cm, 20.5 cm, 16 cm, 20 cm, 25 cm,

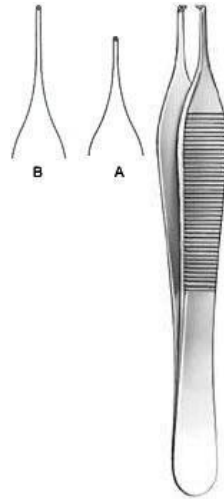

Adson

SLD-05-444-12

Dissecting Forceps
12 cm, 15 cm,



Gillies

SLD-05-445-15

Dissecting Forceps
15.5 cm,



Waugh

SLD-05-446-20

Dissecting Forceps
20.5 cm,



Semken

SLD-05-447-12

Dissecting Forceps
12.5 cm, 15 cm,



Taylor

SLD-05-448-17

Dissecting Forceps
17.5 cm,

Dressing & Tissue Forceps



Taylor
SLD-05-449-17
 Dissecting Forceps
 17 cm,



Taylor
SLD-05-450-17
 Dissecting Forceps
 18.5 cm,



SLD-05-451-06
 Micro Dissecting Forceps
 15.5 cm,



Gerald
SLD-05-452-17
 Dissecting Forceps
 17.5 cm,



Cushing
SLD-05-453-17
 Dissecting Forceps
 18 cm,



Potts-Smith
SLD-05-454-18
 Dissecting Forceps
 18 cm, 21 cm, 24 cm,

Dressing & Tissue Forceps

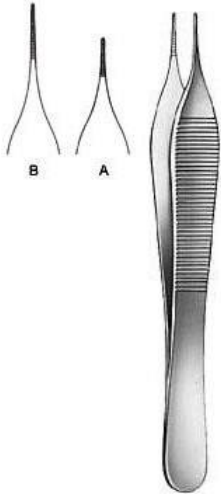

Mikro-Adson
SLD-05-455-12
 Dressing Forceps
 12 cm, 15 cm,

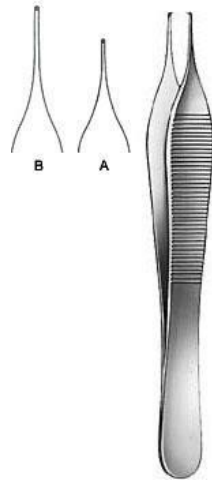

Mikro-Adson
SLD-05-456-12
 Dissecting Forceps
 12 cm, 15 cm,



SLD-05-457-11
 Dissecting Forceps
 10.5 cm,



Micro Jewelers
SLD-05-458-12
 Jeweler Type Forceps
 12 cm Fig. 7,



Jewelers
SLD-05-459-12
 Jeweler Type Forceps
 12 cm Fig. 3,



Jewelers
SLD-05-460-11
 Jeweler Type Forceps
 11 cm Fig. 3c,

Dressing & Tissue Forceps



Jewelers
SLD-05-461-11
Jeweler Type Forceps
11 cm Fig. 5,



Jewelers
SLD-05-462-11
Jeweler Type Forceps
11 cm Fig. 4,



Stille-Barraya
SLD-05-463-18
Dissecting Forceps
18 cm,



Bonney
SLD-05-464-18
Dissecting Forceps
17.5 cm,



Nelson
SLD-05-465-23
Dissecting Forceps
23 cm,



SLD-05-466-10
Dressing Forceps
10 cm, 9.5 cm,

Dressing & Tissue Forceps



SLD-05-467-12
Splinter Forceps smooth jaw
12.5 cm,



SLD-05-468-12
Splinter Forceps smooth jaw
12.5 cm,



SLD-05-469-12
Splinter Forceps
12.5 cm,



SLD-05-470-12
Splinter Forceps
12.5 cm,



SLD-05-471-16
Micro Tying Forceps
15.5 cm,



SLD-05-472-10
Microscopic Forceps super light, blunt
10 cm,

Dressing & Tissue Forceps



SLD-05-473-10
Microscopic Forceps
10 cm,



Shaaf
SLD-05-474-09
Splinter Forceps
9.5 cm,



Littauer
SLD-05-475-08
Cilia Forceps
8.5 cm,



SLD-05-476-09
Cilia Forceps
8.5 cm,



Douglas
SLD-05-477-09
Cilia Forceps
9 cm,



Douglas
SLD-05-478-09
Cilia Forceps
9 cm,

Dressing & Tissue Forceps



Beer
SLD-05-479-09
Cilia Forceps
9 cm,

Splinter Forceps



Phaneuf
SLD-05-501-21
 Hysterectomy Forceps
 20.5 cm,



Wertheim-Cullen
SLD-05-502-21
 Vaginal Clamp
 21 cm,

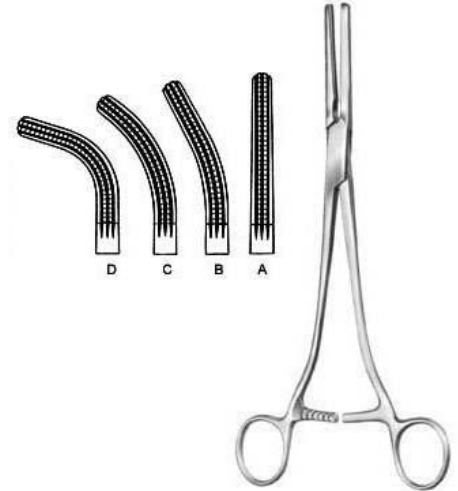

Rogers
SLD-05-503-10
 Hysterectomy Forceps
 21.5 cm Fig. 1, 21 cm Fig. 2, 20.5 cm Fig. 3, 20 cm Fig. 4,



Moynihan
SLD-05-504-23
 Hysterectomy Forceps
 23 cm,



Moynihan
SLD-05-505-24
 Hysterectomy Forceps
 23.5 cm,



Wertheim
SLD-05-506-25
 Hysterectomy Forceps
 26 cm,

Splinter Forceps

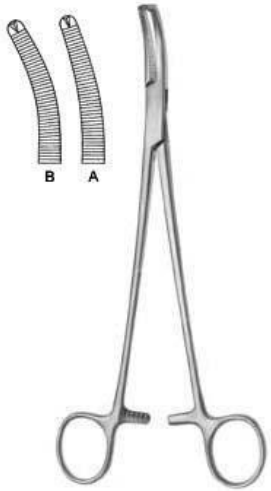

Wertheim
SLD-05-507-22
Hysterectomy Forceps
22.5 cm,



Mikulicz, Baby
SLD-05-508-14
Peritoneum Forceps
14.5 cm,



Mikulicz
SLD-05-509-18
Peritoneum Forceps
20.5 cm,



Mikulicz
SLD-05-510-20
Peritoneum Forceps
18.5 cm,



Mikulicz
SLD-05-511-20
Peritoneum Forceps
20 cm,



Mikulicz
SLD-05-512-21
Peritoneum Forceps
20.5 cm,

Splinter Forceps



Faure
SLD-05-513-20
Peritoneum Forceps
21 cm,

Haemostatic Forceps

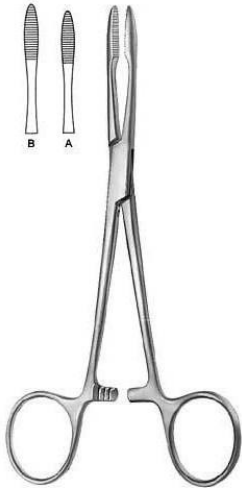

Pean

SLD-05-601-14

Haemostatic Forceps
14.5 cm, 16 cm,

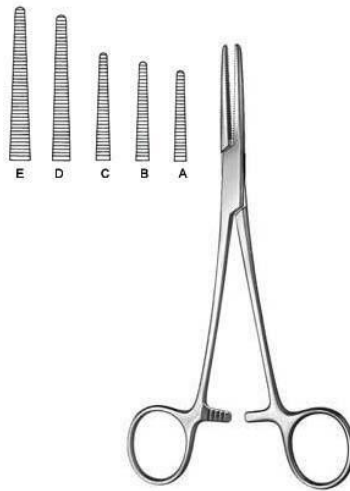

Spencer-Wells

SLD-05-602-13

Haemostatic Forceps
13 cm, 14 cm, 15.5 cm, 18.5 cm, 20 cm,

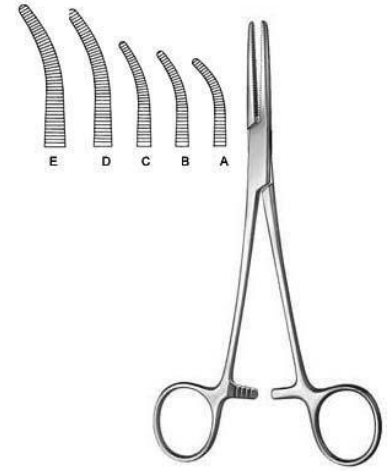

Spencer-Wells

SLD-05-603-13

Haemostatic Forceps
13 cm, 14 cm, 15 cm, 18 cm, 20 cm,



Chaput

SLD-05-604-13

Haemostatic Forceps
12.5 cm,



Tuffier

SLD-05-605-13

Haemostatic Forceps
12.5 cm,

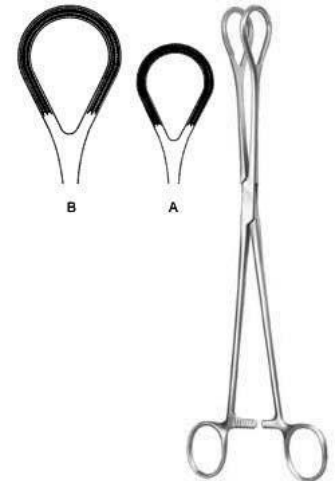

SLD-05-606-25

Organ Grasping Forceps

Haemostatic Forceps



Collin

SLD-05-607-14

Organ Grasping Forceps
15.5 cm, 21 cm,



Collin

SLD-05-608-17

Tumor Grasping Forceps
17 cm,



Pennington

SLD-05-609-15

Haemostatic Forceps
15.5 cm,



Pratt

SLD-05-610-15

Haemostatic Forceps
15 cm,



Martel-Rees

SLD-05-611-14

Face-lift Forceps
13.5 cm,



SLD-05-612-12

Ligature Forceps

Haemostatic Forceps

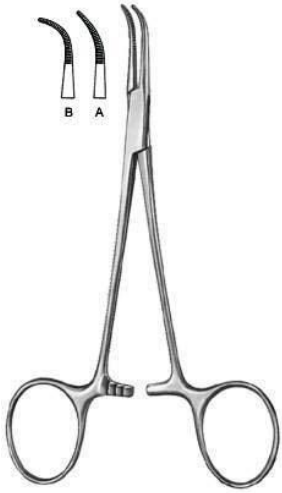

Mixer-Baby

SLD-05-613-01

Dissecting and Ligature Forceps
13.5 cm, 13 cm,

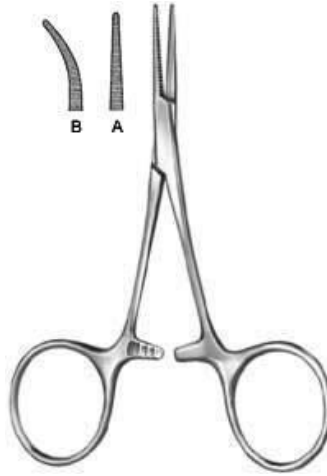

Hartmann

SLD-05-614-10

Haemostatic Forceps
10 cm, 9.5 cm,



SLD-05-615-12

Ligature Forceps

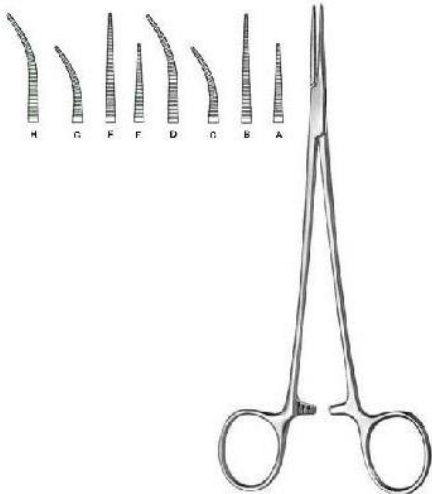

Halsted-Mosquito

SLD-05-616-18

Haemostatic Forceps
12.5 cm, 14.5 cm, 14 cm,

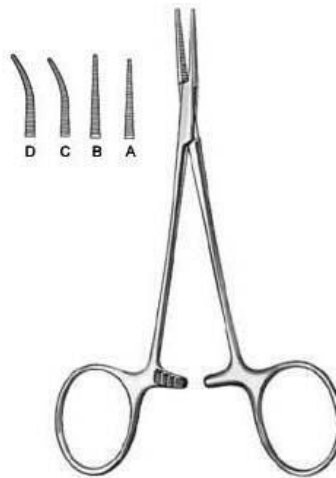

Mikro-Mosquito

SLD-05-617-10

Haemostatic Forceps
10 cm, 12 cm, 9.5 cm, 11.5 cm,

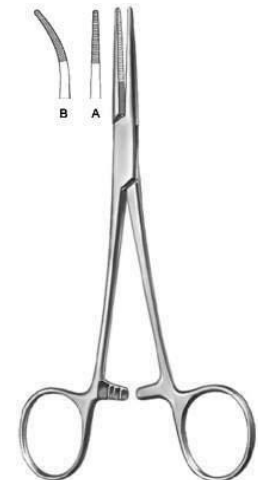

Providence-Hospital

SLD-05-618-14

Haemostatic Forceps
14 cm,

Haemostatic Forceps



Leriche

SLD-05-619-15

Haemostatic Forceps
15.5 cm, 15 cm,

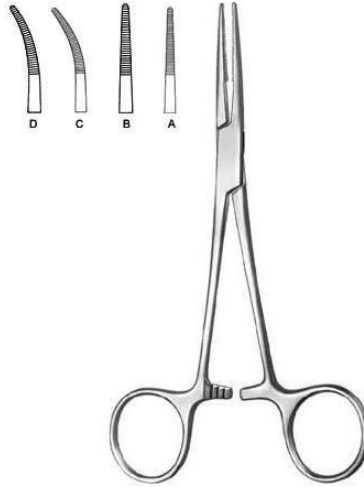

Kelly

SLD-05-620-14

Haemostatic Forceps
14.5 cm, 14 cm,

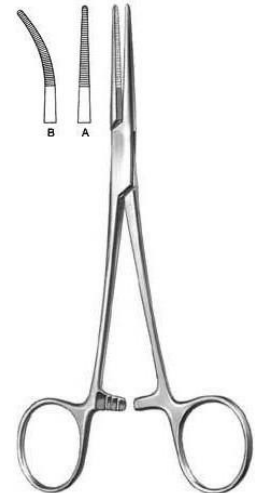

Kelly-Rankin

SLD-05-621-16

Haemostatic Forceps
16 cm, 15.5 cm,



Overholt-Baby

SLD-05-622-14

Dissecting and Ligature Forceps
14.5 cm, 14 cm,



Crile

SLD-05-623-14

Haemostatic Forceps
14.5 cm, 14 cm,



Crile-Rankin

SLD-05-624-16

Haemostatic Forceps
16.5 cm, 16 cm,

Haemostatic Forceps

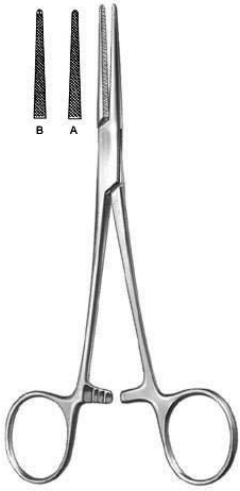

Lovelace
SLD-05-625-15
 Haemostatic Forceps
 16 cm,



Dandy-Mosquito
SLD-05-626-12
 Haemostatic Forceps
 12 cm,

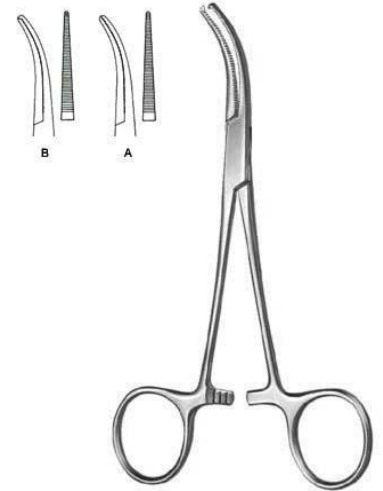

Dandy
SLD-05-627-14
 Haemostatic Forceps
 14.5 cm, 14 cm,



Schnidt
SLD-05-628-18
 Dissecting and Ligature Forceps
 18.5 cm, 19 cm,



Adson
SLD-05-629-18
 Dissecting and Ligature Forceps
 19 cm, 18.5 cm,



Martin-Fuchsig
SLD-05-630-20
 Dissecting and Ligature Forceps
 20.5 cm,

Haemostatic Forceps

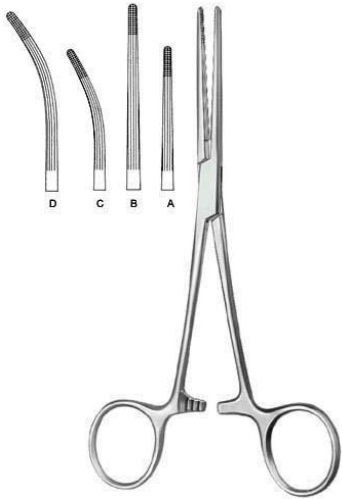

Rochester-Carmalt

SLD-05-631-16

Haemostatic Forceps
17 cm, 20.5 cm, 16.5 cm, 20 cm,

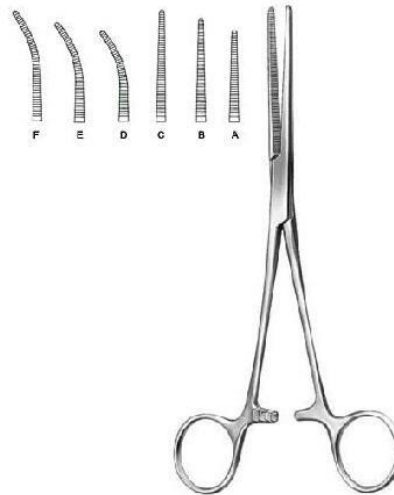

Pean

SLD-05-632-13

Haemostatic Forceps
13.5 cm, 14.5 cm, 17 cm, 13 cm, 14 cm, 16.5 cm,

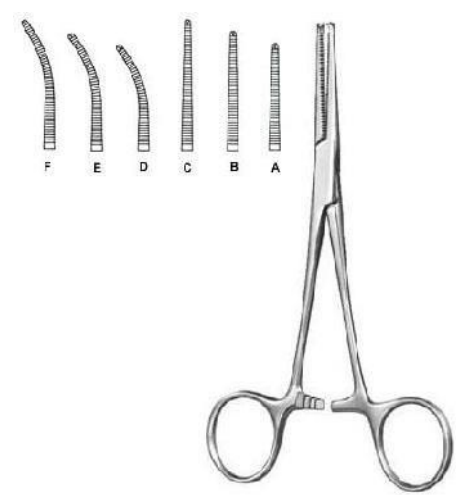

Kocher-Nippon

SLD-05-633-14

Haemostatic Forceps
14.5 cm, 16.5 cm, 18.5 cm, 16 cm, 18 cm,

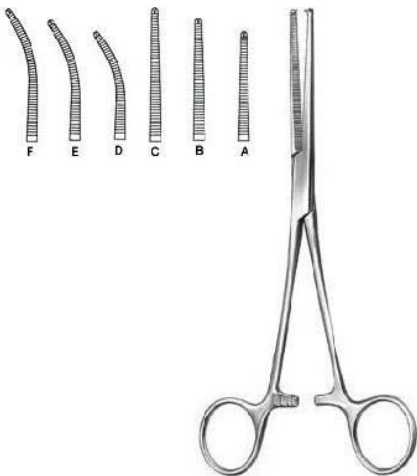

Kocher

SLD-05-635-13

Haemostatic Forceps
13 cm, 14 cm, 16 cm,

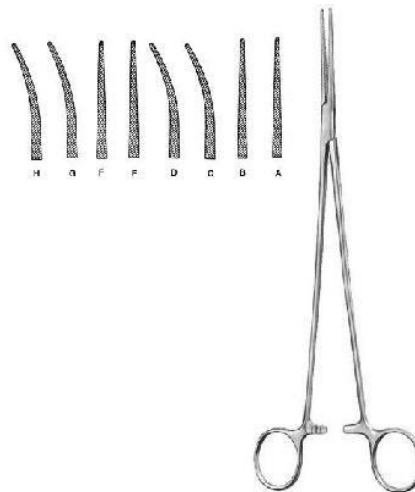

Bengolea

SLD-05-636-20

Haemostatic Forceps
21.5 cm, 26 cm, 21 cm, 21.5 cm,

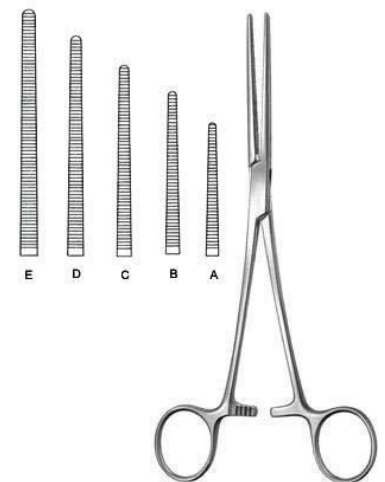

Pean (Rochester)

SLD-05-637-14

Haemostatic Forceps
14.5 cm, 16.5 cm, 18.5 cm, 20.5 cm, 22.5 cm, 24.5 cm, 26 cm, 30.5 cm, 14 cm, 16 cm,

Haemostatic Forceps

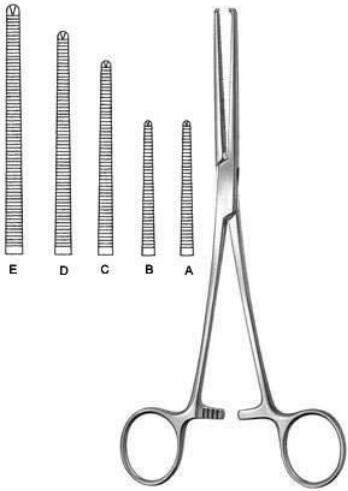

Kocher (Ochsner)

SLD-05-638-14

Haemostatic Forceps

14.5 cm, 16.5 cm, 18.5 cm, 20.5 cm, 22.5 cm, 24.5 cm, 26 cm, 30.5 cm,

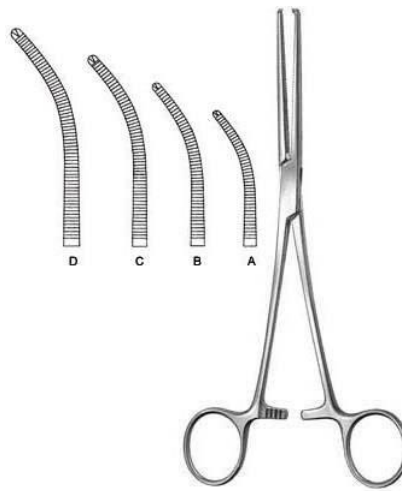

Kocher (Ochsner)

SLD-05-639-14

Haemostatic Forceps

14 cm, 16 cm, 18 cm, 20 cm, 22 cm, 24 cm, 25.5 cm, 30 cm,

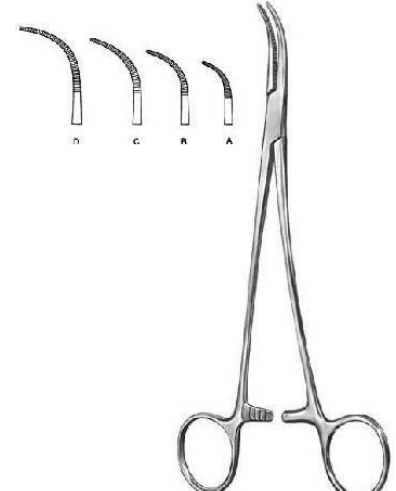

Overholt-Martin

SLD-05-640-01

Dissecting and Ligature Forceps

18.5 cm Fig. 1, 20.5 cm Fig. 2, 21 cm Fig. 3, 21.5 cm Fig. 4, 24.5 cm Fig. 5,



Mixter-Baby

SLD-05-641-18

Dissecting and Ligature Forceps
18.5 cm,



Adson-Baby

SLD-05-642-14

Dissecting and Ligature Forceps
14.5 cm, 18 cm,



Heiss

SLD-05-643-20

Dissecting and Ligature Forceps
21 cm, 20.5 cm, 20 cm,

Haemostatic Forceps



Overholt-Mixer
SLD-05-644-21

Dissecting and Ligature Forceps
21.5 cm,

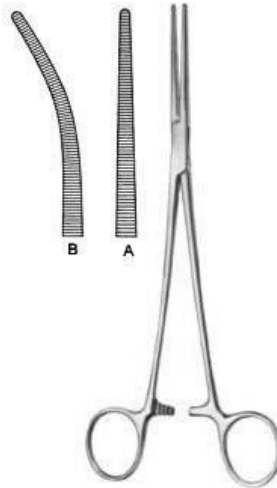

Roberts

SLD-05-645-22

Dissecting and Ligature Forceps
22.5 cm, 21.5 cm,

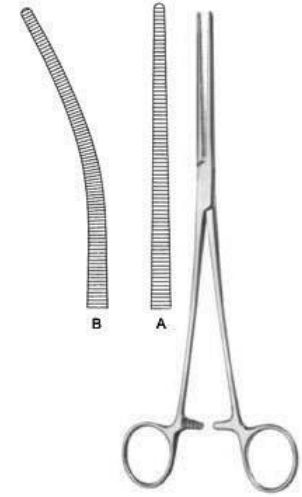

Sarot

SLD-05-646-24

Dissecting and Ligature Forceps
25 cm, 24.5 cm,

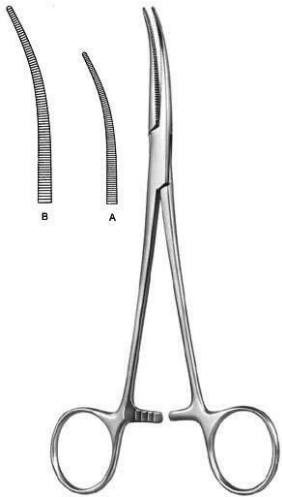

Crafoord

SLD-05-647-18

Dissecting and Ligature Forceps
18 cm, 24.5 cm,

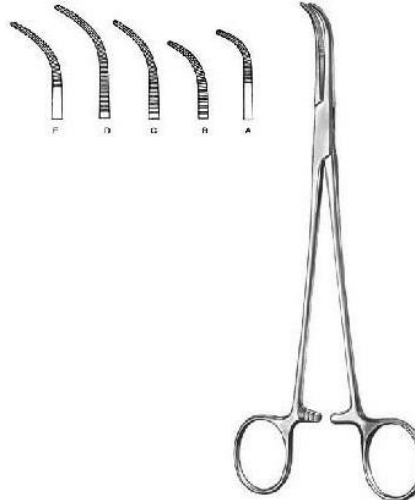

Overholt-Geissendorfer

SLD-05-648-01

Dissecting and Ligature Forceps
20.5 cm Fig. 1, 20 cm Fig. 2, 21.5 cm Fig. 3, 22 cm Fig. 4, 21.5 cm Fig. 5, 22 cm Fig. 6, 27 cm Fig. 1, 26.5 cm Fig. 2, 27.5 cm Fig. 3, 28 cm Fig. 4,

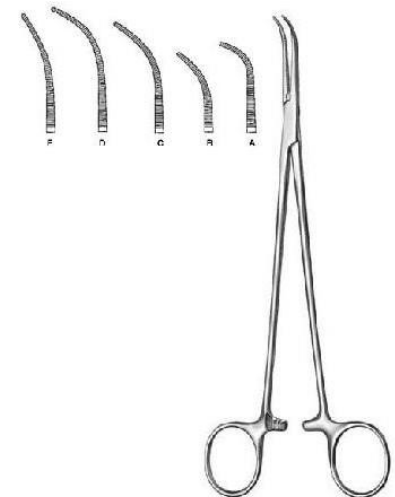

Overholt-Fino

SLD-05-649-00

Dissecting and Ligature Forceps
21.5 cm, 21 cm, 22 cm, 23 cm, 22.5 cm,

Haemostatic Forceps

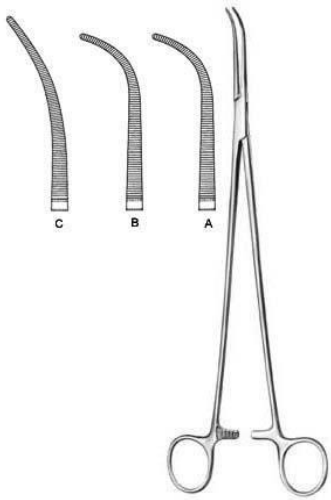

Overholt

SLD-05-650-00

Dissecting and Ligature Forceps
29.5 cm, 30 cm,



Overholt-Mini

SLD-05-651-01

Dissecting and Ligature Forceps
15 cm, 20 cm,

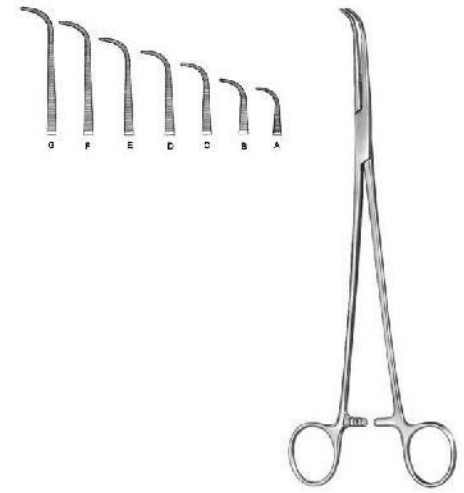

Gemini

SLD-05-652-13

Dissecting and Ligature Forceps
13 cm, 16 cm, 18 cm, 21 cm, 23 cm, 25 cm, 28 cm,

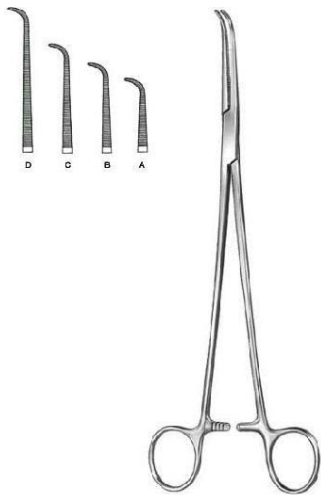

Mini-Gemini

SLD-05-653-18

Dissecting and Ligature Forceps
18 cm, 22.5 cm, 25 cm, 28.5 cm,

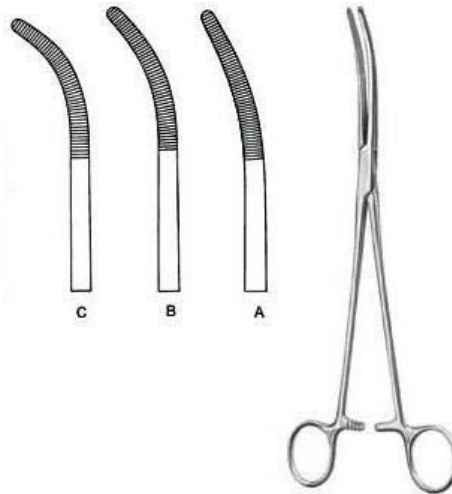

Rumel

SLD-05-654-01

Dissecting and Ligature Forceps
24 cm Fig. 1, 23.5 cm Fig. 2, 23 cm Fig. 3, 24 cm Fig. 4, 23.5 cm Fig. 5,

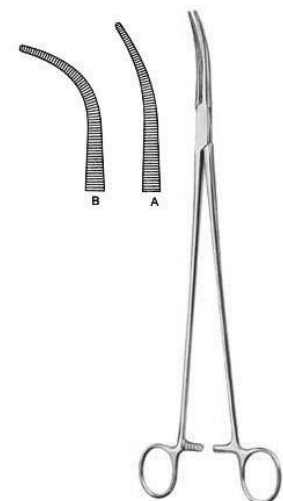

Zenker

SLD-05-655-01

Dissecting and Ligature Forceps
29.5 cm, 28.5 cm,

Haemostatic Forceps



Mixer-Baby

SLD-05-656-14

Dissecting and Ligature Forceps
13.5 cm,



Mixer

SLD-05-657-15

Dissecting and Ligature Forceps
16 cm, 18 cm,



Mixer-O Shaugnessy

SLD-05-658-19

Dissecting and Ligature Forceps
18 cm,



Mixer

SLD-05-659-22

Dissecting and Ligature Forceps
22.5 cm,



Mixer

SLD-05-660-23

Dissecting and Ligature Forceps
23 cm,

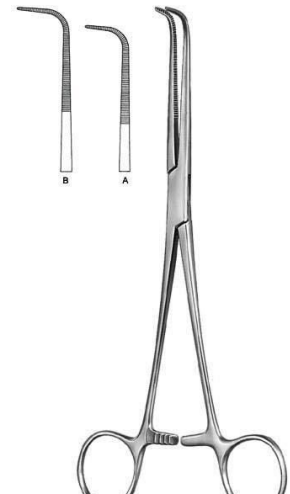

Wickstrom

SLD-05-661-21

Dissecting and Ligature Forceps
21 cm, 24.5 cm,

Haemostatic Forceps

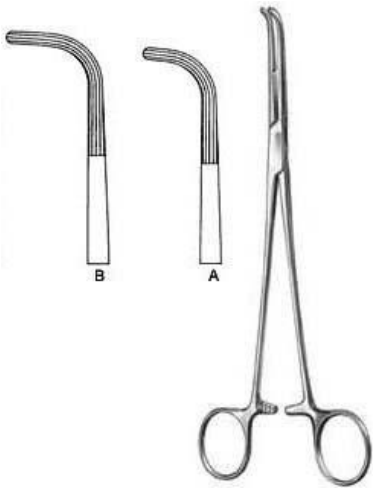

Mixer

SLD-05-662-22

Dissecting and Ligature Forceps
22.5 cm, 26 cm, 28 cm,



Mc Quigg-Mixer

SLD-05-663-22

Dissecting and Ligature Forceps
23.5 cm,



Lower

SLD-05-664-18

Dissecting and Ligature Forceps
18.5 cm,

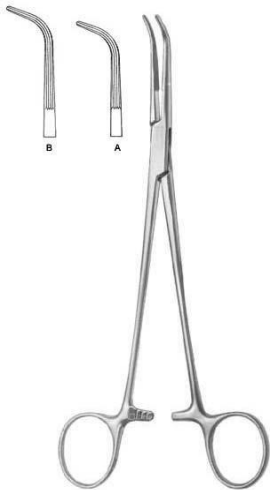

Lahey

SLD-05-665-19

Bile Duct Clamp
19.5 cm, 22.5 cm,



Finochietto

SLD-05-666-24

Dissecting and Ligature Forceps
24 cm,



Uro-Tangential

SLD-05-667-01

Tangential Forceps
25 cm, 27 cm,

Haemostatic Forceps

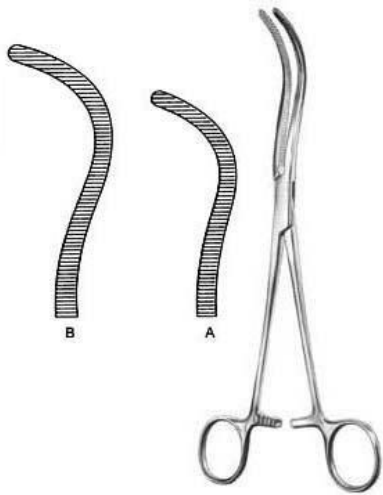

Guyon

SLD-05-668-20

Kidney Pedicle Clamp
23 cm, 24 cm,



Guyon

SLD-05-669-23

Kidney Pedicle Clamp
19.5 cm, 21.5 cm, 24 cm,



Desjardins

SLD-05-670-21

Bile Duct Clamp
21 cm,

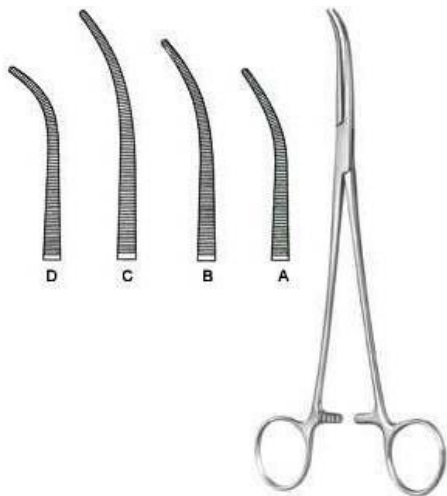

Kelly

SLD-05-671-19

Dissecting and Ligature Forceps

19.5 cm Fig. 1, 22.5 cm Fig. 1, 24.5 cm Fig. 1,
19 cm Fig. 2, 22 cm Fig. 2, 24 cm Fig. 2, 18.5
cm Fig. 3, 21.5 cm Fig. 3, 23.5 cm Fig. 3,



Lawrence

SLD-05-672-28

Dissecting and Ligature Forceps
28 cm,



Meeker

SLD-05-673-28

Dissecting and Ligature Forceps
28 cm,

Haemostatic Forceps



Negus

SLD-05-674-19

Haemostatic Forceps
19.5 cm Fig. 1, 20 cm Fig. 2,

Towel & Tubing Clamps



Schaedel
SLD-05-701-09
Towel Clamp sharp
9 cm,



Jones
SLD-05-702-05
Towel Clamp sharp
5.5 cm, 8.5 cm,



Jones-Martin
SLD-05-703-09
Towel Clamp sharp
8.5 cm,



Backhaus
SLD-05-704-11
Towel Clamp
11.5 cm, 13 cm,



Backhaus
SLD-05-705-11
Towel Clamp
11.5 cm,



Backhaus
SLD-05-706-08
Towel Clamp
9 cm, 11.5 cm, 13 cm, 16 cm,

Towel & Tubing Clamps

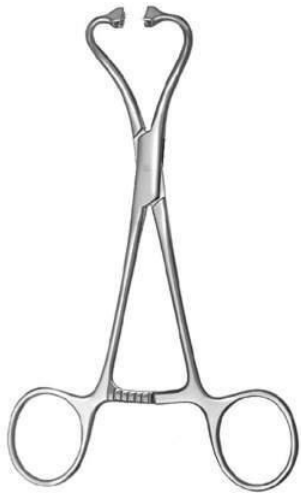

Peers-Bertram modif.
SLD-05-707-15

Towel Clamp wide jaw for tube fixation
15.5 cm,



Rieder
SLD-05-708-13

Towel Clamp
13.5 cm,

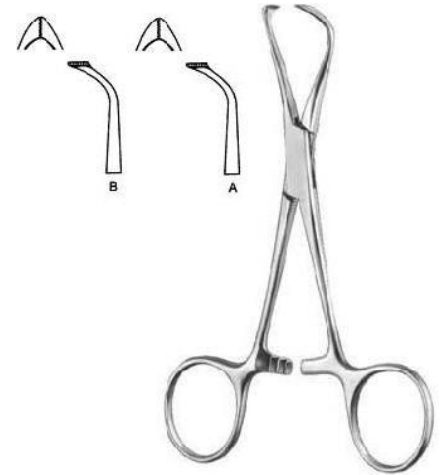

Lorna
SLD-05-709-10

Towel Clamp fine serrated, wide jaw
9.5 cm, 13 cm,



Bernhard
SLD-05-710-16

Towel Clamp
16.5 cm,

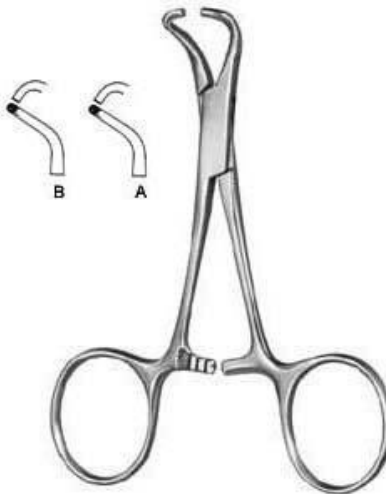

Tohoku
SLD-05-711-10

Towel Clamp
10.5 cm blunt, 13.5 cm blunt, 14.5 cm,

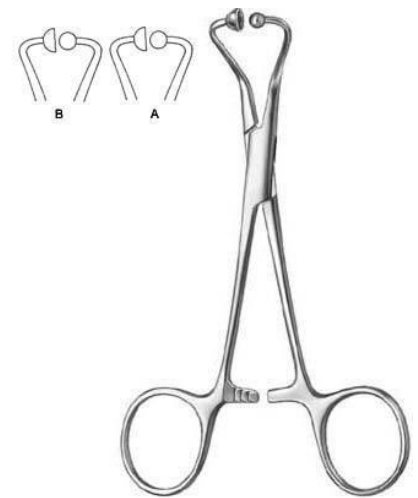

SLD-05-712-11

Towel Clamp for paper clothes
11.5 cm, 14 cm,

Towel & Tubing Clamps



Lane
SLD-05-713-20
 Towel Clamp
 19.5 cm,



SLD-05-714-06
 Tube Holder for fixation of six tubes



SLD-05-715-14
 Tubing Clamp extra long ratchet
 14 cm,



SLD-05-716-16
 Tubing Clamp
 16.5 cm,

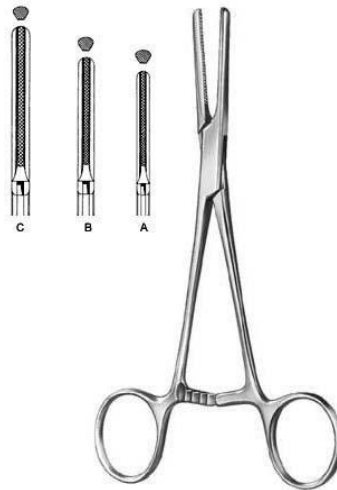

SLD-05-717-15
 Tubing Clamp
 15.5 cm, 19 cm, 20.5 cm,

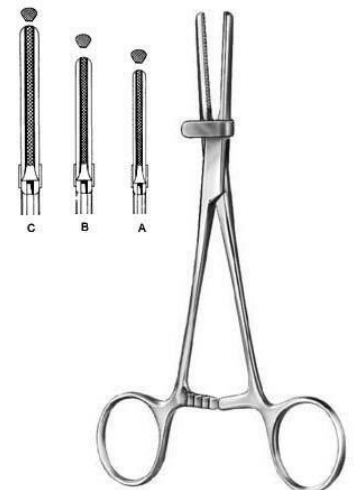

SLD-05-718-15
 Tubing Clamp with safety guard
 15.5 cm, 19 cm, 20.5 cm,

Dressing & Sponge Forceps

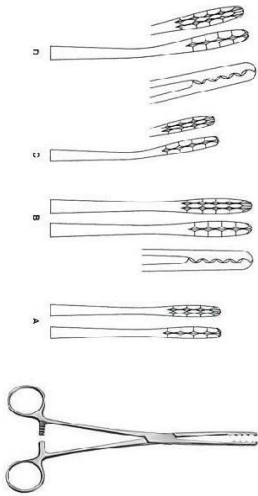

Ulrich

SLD-05-801-22

Dressing Forceps
22.5 cm, 26.5 cm,

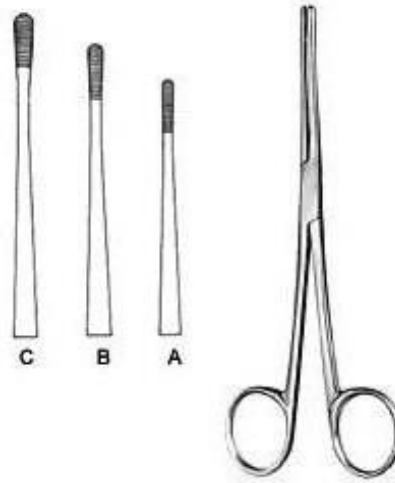

Lister

SLD-05-802-13

Sinus Forceps
13 cm, 16 cm, 18 cm,



Martin

SLD-05-803-17

Dressing Forceps
17.5 cm, 17 cm,

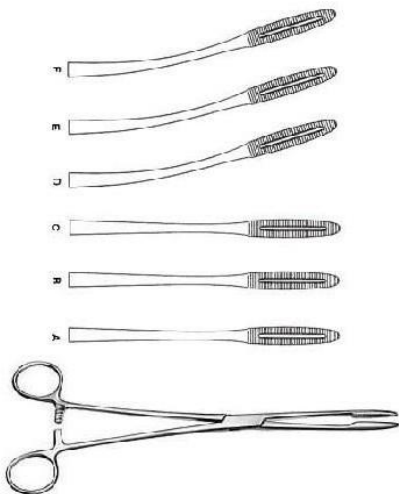

Gross-Maier

SLD-05-804-20

Dressing Forceps
20.5 cm, 22 cm, 26.5 cm, 20 cm, 21.5 cm, 26 cm,



SLD-05-805-40

Tunneling Forceps
39.5 cm,



Collin

SLD-05-806-25

Dressing Forceps
25.5 cm,

Dressing & Sponge Forceps



Cheron
SLD-05-807-25
Dressing Forceps
23.5 cm,



Bozemann
SLD-05-808-26
Sponge Forceps
26 cm,

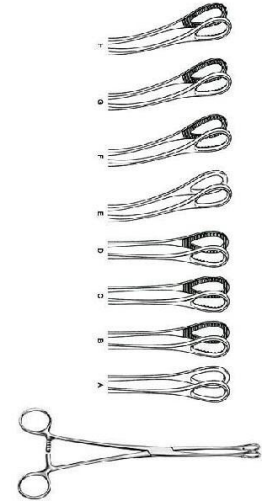

Foerster
SLD-05-809-25
Sponge Forceps
25 cm, 18 cm, 20.5 cm, 24.5 cm, 17.5 cm, 20 cm, 24.5 cm,

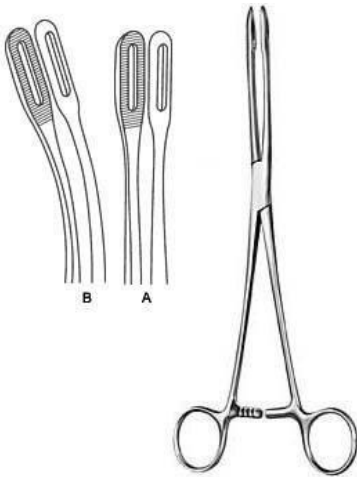

Foerster
SLD-05-810-25
Sponge Forceps
25 cm, 24.5 cm,

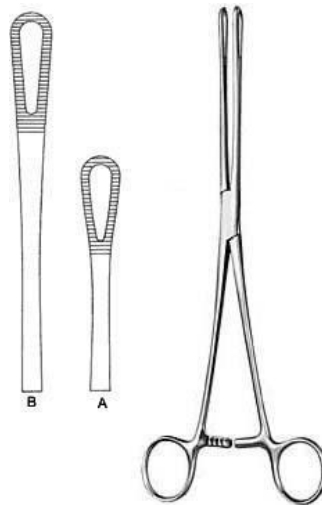

Rampley
SLD-05-811-18
Sponge Forceps
18.5 cm, 24.5 cm,

Retractors



Vickers
SLD-05-901-18
 Skin Hooklet
 18.5 cm,



Vickers
SLD-05-902-01
 Bone Hooklet
 17 cm,



Vickers
SLD-05-903-01
 Tendon Hooklet
 17 cm,



Vickers
SLD-05-904-02
 Hooklet
 16 cm,

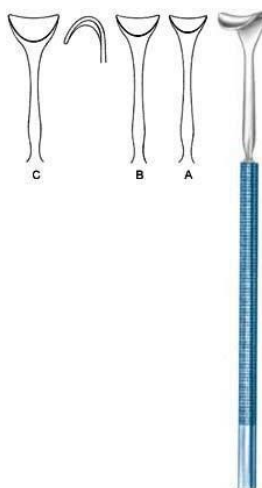

Vickers
SLD-05-905-12
 Saddle Hook
 14 cm,



Graefe
SLD-05-906-01
 Micro Hooklet
 15 cm,

Retractors

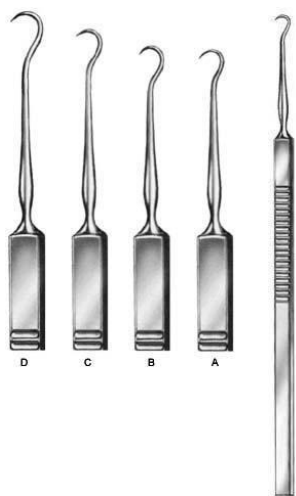

SLD-05-907-01

Skin Hook

16 cm Fig. 1, 16 cm Fig. 2, 16 cm Fig. 3, 16 cm Fig. 4,



O Connor

SLD-05-908-16

Skin Hook
16 cm,

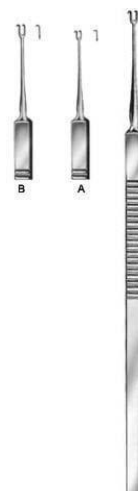

Guthrie

SLD-05-909-01

Skin Hook
15.5 cm,

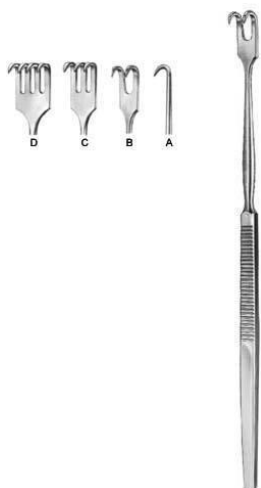

SLD-05-910-01

Hooklet
16.5 cm,

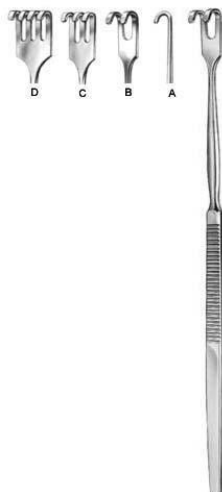

SLD-05-911-01

Hooklet
16.5 cm,



SLD-05-912-02

Hooklet
16 cm,

Retractors



SLD-05-913-04
Hooklet
16.5 cm,



SLD-05-914-12
Vessel Hook
12 cm,

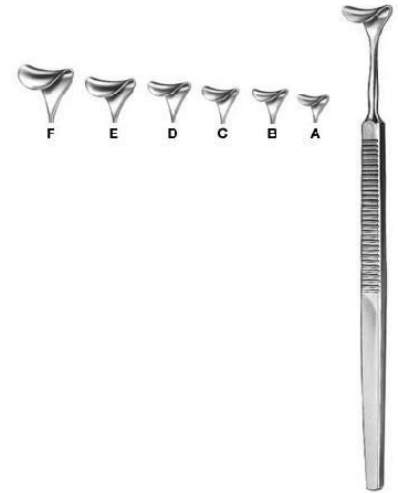

Desmarres
SLD-05-915-08
Saddle Hook
16 cm 8 mm, 16 cm 10 mm, 16 cm 12 mm, 16 cm 14 mm, 16 cm 16 mm, 16 cm 18 mm,

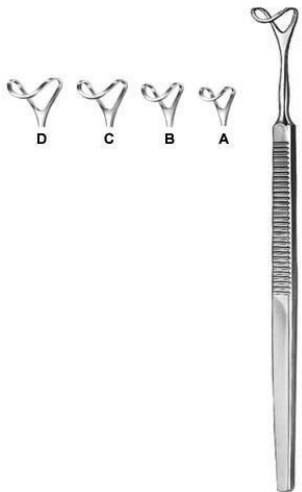

SLD-05-916-12
Saddle Hook
16 cm 12 mm, 16 cm 14 mm, 16 cm 16 mm, 16 cm 18 mm,

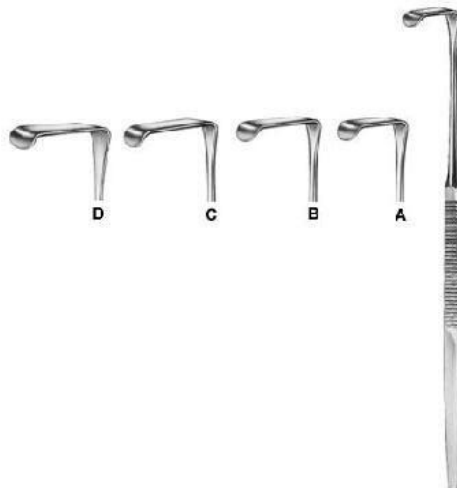

Langenbeck-Mini
SLD-05-917-10
Hooklet
16 cm,



SLD-05-918-16
Hooklet
16 cm 14 x 8,

Retractors



SLD-05-919-01

Hooklet
16.5 cm,



SLD-05-920-01

Hooklet
16.5 cm,



Meyerding

SLD-05-921-01

Hooklet
17.5 cm Fig. 1, 17.5 cm Fig. 2, 17.5 cm Fig. 3, 17.5 cm Fig. 4, 17.5 cm Fig. 5, 17.5 cm Fig. 6,



Senn-Green

SLD-05-922-01

Hooklet
15 cm Fig. 1, 15 cm Fig. 2,



Ragnell-Davis

SLD-05-923-14

Hooklet
14 cm,

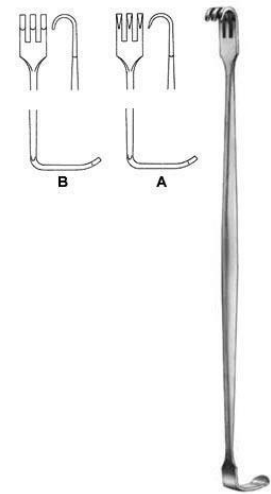

Senn-Miller

SLD-05-924-16

Hooklet
16 cm,



Cushing
SLD-05-925-20
 Retractor
 20.5 cm,



Cushing
SLD-05-926-08
 Saddle Hook
 20.5 cm 8 mm wide, 20.5 cm 10 mm wide, 20.5 cm 12 mm wide, 20.5 cm 14 mm wide, 20.5 cm 16 mm wide, 20.5 cm 18 mm wide,

Cushing
SLD-05-927-08
 Saddle Hook 8 mm to 18 mm wide
 24 cm,



Brom
SLD-05-928-01
 Vein Hook
 19.5 cm,



Strandell-Stille
SLD-05-929-01
 Hooklet
 19 cm Fig. 1, 19 cm Fig. 2,

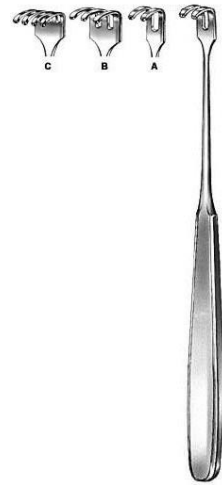

Klapp
SLD-05-930-01
 Retractor 12 x 6, 12 x 11, 15 x 11
 17.5 cm,

Retractors



SLD-05-931-04

Hooklet
16.5 cm,

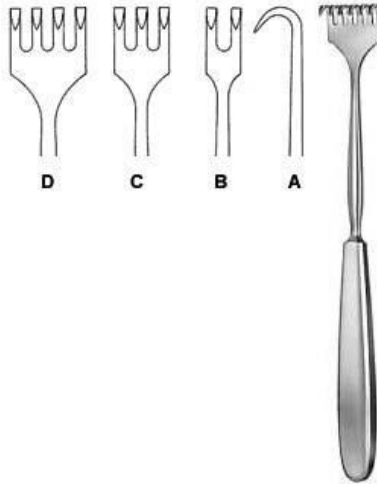

Volkmann
SLD-05-932-01

Retractor
21.5 cm,

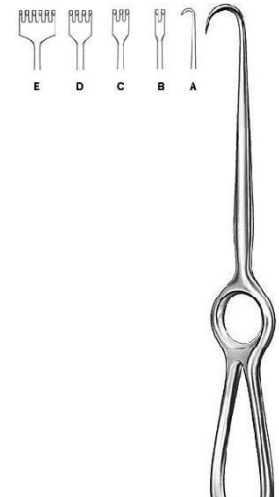

Volkmann
SLD-05-933-01

Retractor
22 cm, 21.5 cm,



Kocher
SLD-05-934-01

Retractor
22 cm,

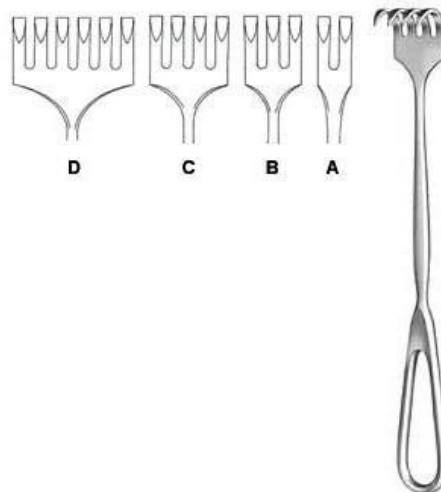

Martin
SLD-05-935-02

Retractor
22.5 cm,

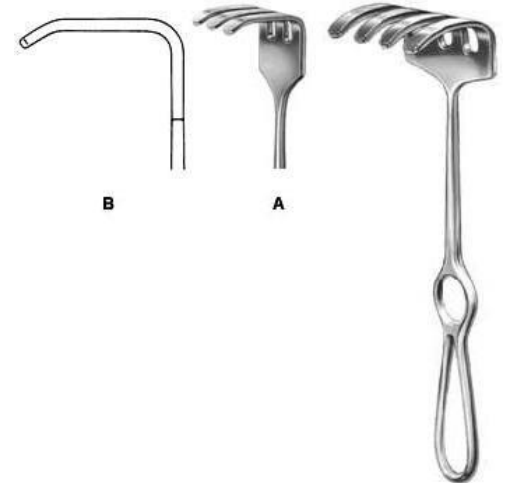

Ollier
SLD-05-936-03
Retractor
23 cm 36 x 30, 23 cm 36 x 60,

Retractors

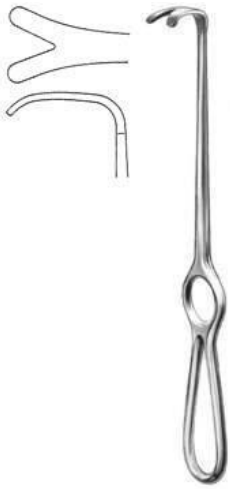

Wassmund
SLD-05-937-02
 Retractor
 20.5 cm 33 x 21,

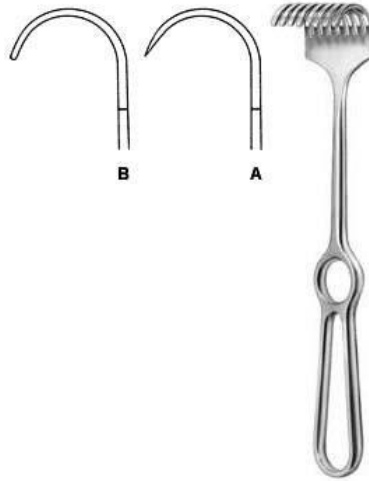

Korte
SLD-05-938-08
 Retractor
 24.5 cm 40 x 30,

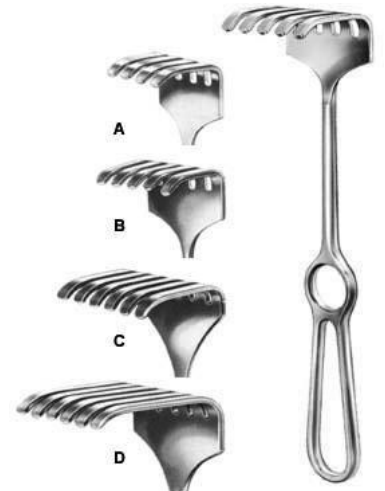

Israel
SLD-05-939-04
 Retractor
 25.5 cm,

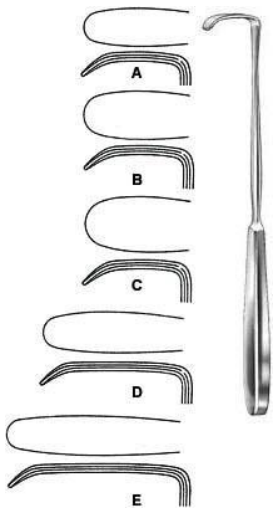

Langenbeck
SLD-05-940-01
 Retractor
 22.5 cm 30 x 11 mm, 22.5 cm 30 x 14 mm, 22.5 cm 30 x 16 mm, 22.5 cm 40 x 11 mm, 22.5 cm 50 x 11 mm,

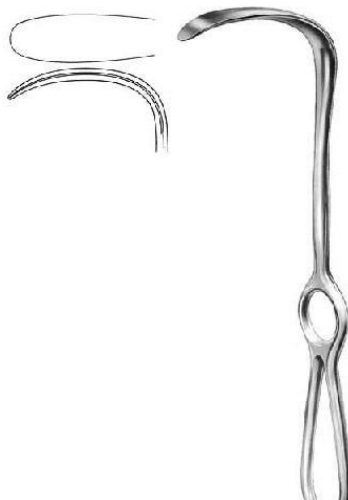

Langenbeck
SLD-05-942-21
 Retractor
 21 cm 65 x 20 mm,



Langenbeck
SLD-05-943-21
 Retractor
 22.5 cm 85 x 15 mm,

Retractors



Lahey

SLD-05-944-19

Retractor

19.5 cm 36 x 19 mm,



Little

SLD-05-945-20

Retractor

20 cm 13 x 15 mm,

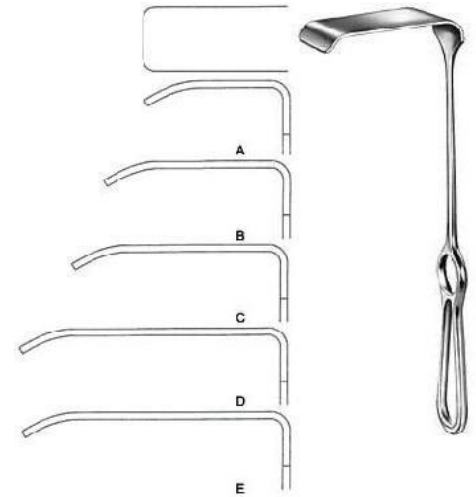

Kocher

SLD-05-946-18

Retractor

23 cm 43 x 18 mm, 23 cm 53 x 20 mm, 23 cm 63 x 25 mm, 23 cm 77 x 30 mm, 23 cm 78 x 40 mm,

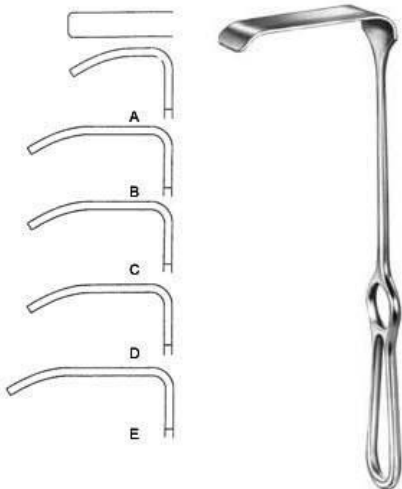

Kocher-Langenbeck

SLD-05-947-01

Retractor

21.5 cm 25 x 6 mm, 21.5 cm 35 x 8 mm, 21.5 cm 35 x 11 mm, 21.5 cm 35 x 15 mm, 21.5 cm 40 x 11 mm, 21.5 cm 55 x 11 mm, 21.5 cm 70 x 14 mm, 21.5 cm 80 x 12 mm,

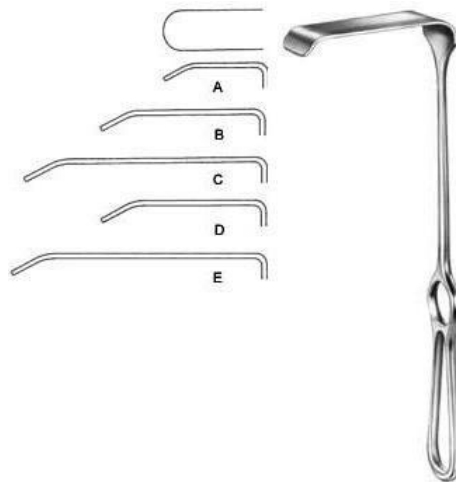

Kocher-Langenbeck

SLD-05-948-01

Retractor

21.5 cm 25 x 10 mm, 21.5 cm 40 x 13 mm, 21.5 cm 60 x 13 mm, 21.5 cm 40 x 18 mm, 21.5 cm 60 x 18 mm, 21.5 cm 85 x 18 mm, 21.5 cm 60 x 25 mm, 21.5 cm 85 x 25 mm,

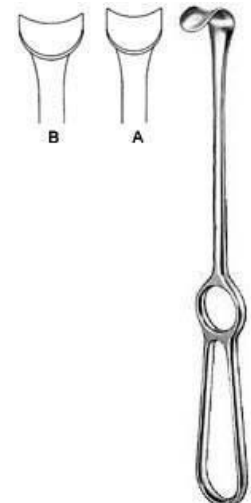

Kocher

SLD-05-949-01

Retractor

21.5 cm 22 x 12 mm, 21.5 cm 24 x 14 mm,

Retractors

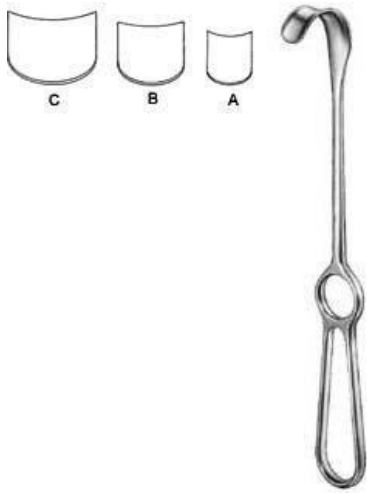

Kocher
SLD-05-950-01

Retractor

22 cm 42 x 10 mm, 22 cm 42 x 15 mm, 22 cm 43 x 20 mm,

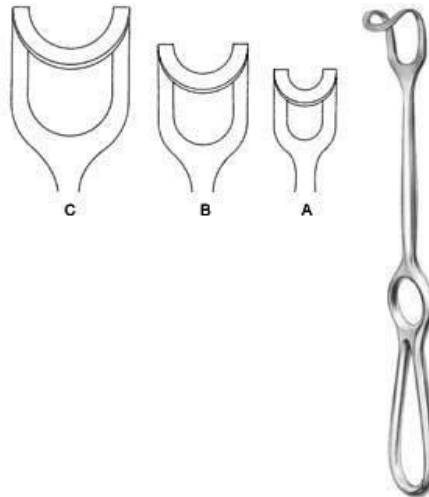

Middeldorpf
SLD-05-951-01

Retractor

21.5 cm 18 x 17 mm, 23 cm 25 x 22 mm, 24.5 cm 30 x 31 mm,

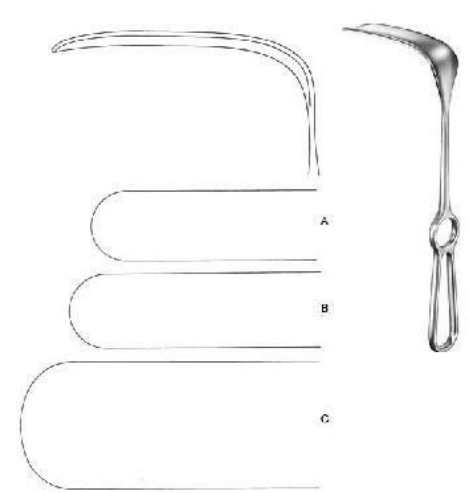

Doyen-Stille
SLD-05-952-01

Retractor

26 cm 97 x 29 mm, 26 cm 101 x 31 mm, 26 cm 127 x 52 mm,



Hosel
SLD-05-953-01

Retractor

26 cm 63 x 21 mm, 26 cm 83 x 30 mm, 26 cm 103 x 30 mm, 26 cm 120 x 30 mm, 26 cm 140 x 30 mm, 26 cm 140 x 40 mm,

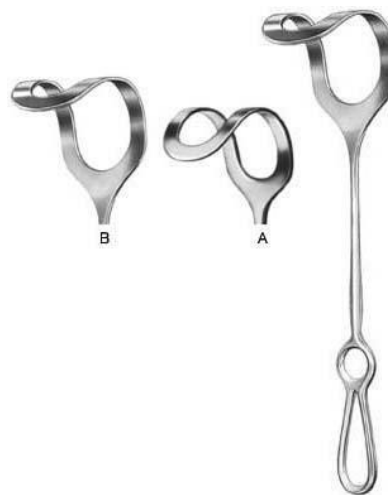

Middeldorpf
SLD-05-954-01

Retractor

27 cm 48 x 45 mm, 27 cm 52 x 50 mm, 27 cm 60 x 70 mm,

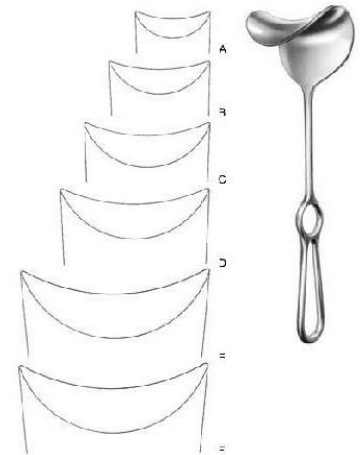

Fritsch
SLD-05-955-00

Retractor

23.5 cm 37 x 31 mm, 24 cm 38 x 40 mm, 25 cm 43 x 51 mm, 25 cm 49 x 61 mm, 25.5 cm 48 x 75 mm, 25.5 cm 65 x 85 mm,

Retractors



Doyen
SLD-05-956-25
 Retractor
 24 cm 48 x 88 mm,



Kocher
SLD-05-957-22
 Retractor
 24 cm 73 x 25 mm,



Kocher
SLD-05-958-01
 Retractor
 25 cm 80 x 45 mm, 25 cm 80 x 55 mm, 25 cm
 80 x 65 mm,



Martin
SLD-05-959-25
 Retractor
 26 cm 110 x 27 mm,

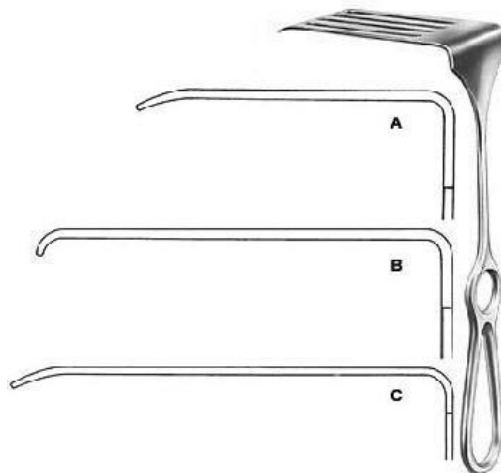

Coryllos
SLD-05-960-01
 Retractor
 24 cm 85 x 22 mm, 24 cm 108 x 43 mm, 24 cm
 119 x 65 mm,



Davidson
SLD-05-961-01
 Retractor
 19 cm 80 x 54 mm, 18.5 cm 80 x 95 mm,

Retractors

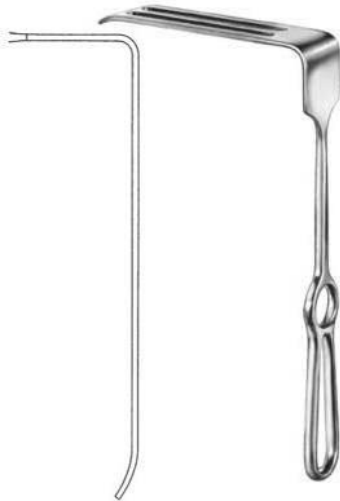

Sauerbruch

SLD-05-962-25

Retractor
25.5 cm 127 x 38 mm,

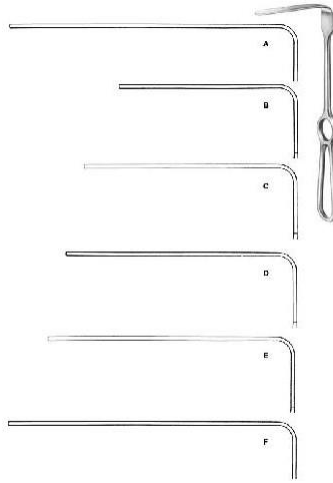

Brunner

SLD-05-963-08

Retractor
25.5 cm 84 x 20 mm, 25.5 cm 104 x 25 mm, 25.5 cm 124 x 30 mm, 25.5 cm 130 x 30 mm, 25.5 cm 144 x 30 mm, 25.5 cm 160 x 30 mm, 25.5 cm 164 x 30 mm,

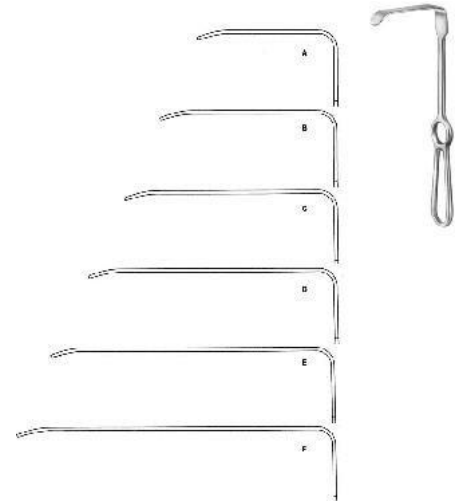

Brunner

SLD-05-964-08

Retractor
25.5 cm 82 x 20 mm, 25.5 cm 102 x 20 mm, 25.5 cm 122 x 25 mm, 25.5 cm 140 x 25 mm, 25.5 cm 162 x 30 mm, 25.5 cm 182 x 30 mm,

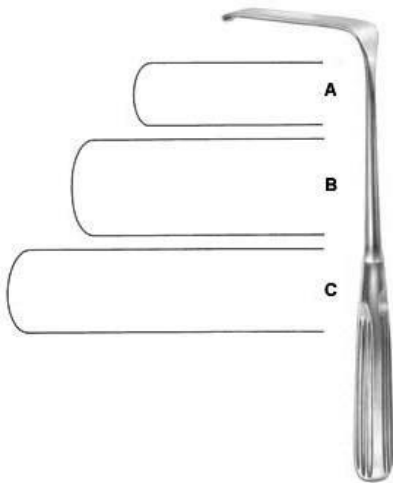

Sauerbruch

SLD-05-965-01

Retractor
22.5 cm 50 x 15mm, 22.5 cm 63 x 23mm, 22.5 cm 80 x 20mm,



Deaver

SLD-05-966-01

Retractor
18 cm 19mm,

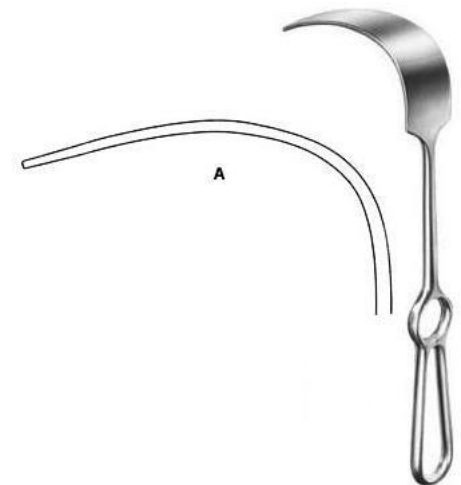

Mikulicz

SLD-05-968-01

Retractor
25 cm 90 x 35mm, 25 cm 125 x 50mm, 25 cm 160 x 50mm,

Retractors



Mikulicz
SLD-05-969-26
 Retractor
 26 cm 90 x 55mm,

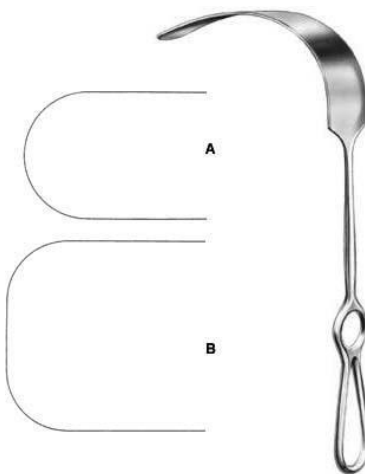

Kelly
SLD-05-970-01
 Retractor
 27.5 cm 205 x 38mm, 27.5 cm 205 x 57mm,



Farabeuf
SLD-05-971-00
 Retractor
 15 cm Fig. 1 = 23 x 16, 15 cm Fig. 1 = 26 x 16, 15 cm Fig. 2 = 27 x 16, 15 cm Fig. 2 = 30 x 16,

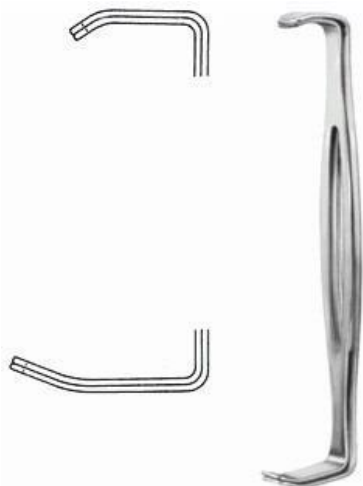

Parker-Langenbeck
SLD-05-972-00
 Retractor
 21.5 cm Fig. 1 = 21x15mm, 21.5 cm Fig. 1 = 40x15mm, 21.5 cm Fig. 2 = 25x15mm, 21.5 cm Fig. 2 = 45x15mm,



Alm
SLD-05-973-07
 Wound Spreaders, self-retaining
 7 cm,



Alm
SLD-05-974-07
 Wound Spreaders, self-retaining
 7 cm,

Retractors



Gosset
SLD-05-975-22
Abdominal Retractor
18.5 cm,



Balfour-Baby
SLD-05-976-00
Abdominal Retractor spreading 90mm, 1
central blade 24 x 20mm
12.5 cm,



Balfour
SLD-05-977-00
Abdominal Retractor spreading 180mm,
lateral blades 70 x 35mm, 1 central blade
20 cm,

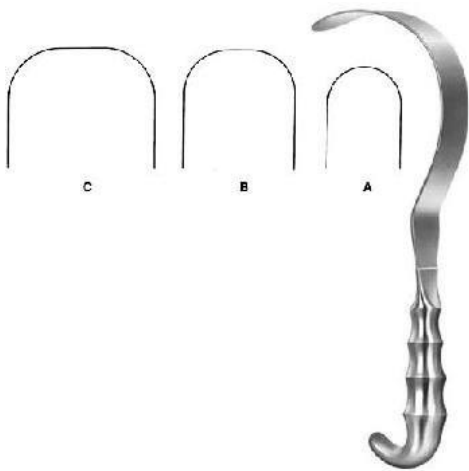

Deaver
SLD-05-967-04
Retractor
31.5 cm 25mm, 31.5 cm 38mm, 31.5 cm
50mm, 31.5 cm 100mm,

Probes



SLD-05-1001-11

Probe

11.5 cm, 13 cm, 14.5 cm, 16 cm, 18 cm, 20 cm, 25 cm, 30 cm,



SLD-05-1002-11

Probe

11.5 cm, 13 cm, 14.5 cm, 16 cm, 18 cm, 20 cm, 25 cm, 30 cm,

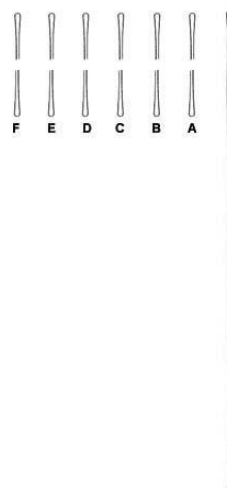

SLD-05-1003-13

Probe

13 cm, 14.5 cm, 16 cm, 18 cm, 20 cm, 25 cm,



SLD-05-1004-13

Probe with eye

13 cm, 14.5 cm, 16 cm,

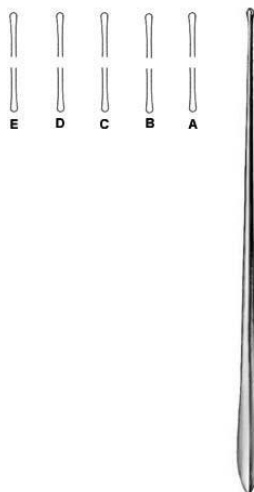

SLD-05-1006-13

Myrtle Leaf Probe

13 cm, 14.5 cm, 16 cm, 18 cm, 20 cm,



SLD-05-1007-13

Grooved Director

13 cm, 14 cm, 16 cm,

Probes



SLD-05-1008-13
Grooved Director
13 cm, 14.5 cm, 16 cm,



Doyen
SLD-05-1009-14
Grooved Director
14.5 cm,



Nelaton
SLD-05-1010-16
Grooved Director
16 cm,

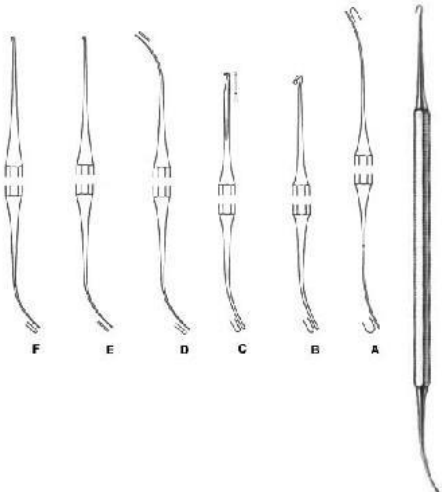

Varady
SLD-05-1011-01
Phlebodissector
18 cm, 17.5 cm,

Plaster

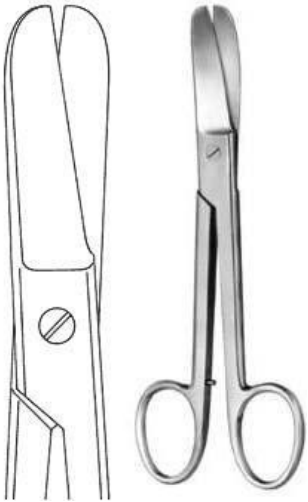

Lorenz

SLD-06-101-23

Bandage Scissors heavy pattern
23 cm,

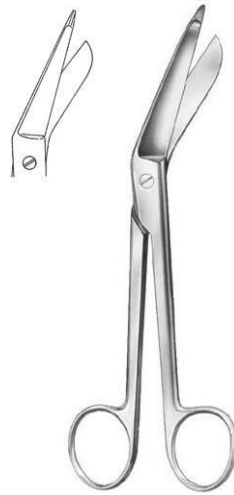

Lister

SLD-06-102-14

Bandage Scissors
14.5 cm, 18.5 cm, 20 cm,



Bergmann

SLD-06-103-23

Plaster Shears
23.5 cm,



Esmarch

SLD-06-104-20

Plaster Shears heavy pattern, short blades
20 cm,



SLD-06-105-15

Bandage Scissors black plastic ring with
autodavable
16 cm, 19 cm,



SLD-06-106-18

Bandage Scissors black plastic rings
19 cm, 16 cm,

Plaster

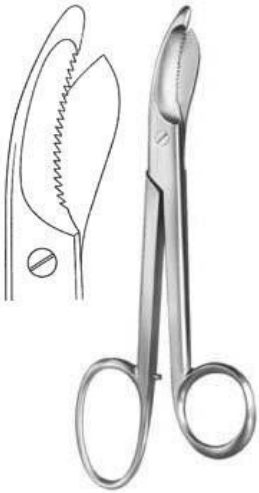

Bruns
SLD-06-107-24
Plaster Scissors
24 cm,

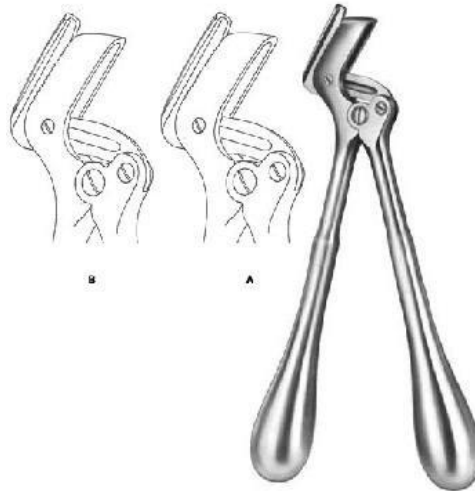

Stille-Martin
SLD-06-108-23
Plaster Shears
23 cm, 27 cm, 38 cm,

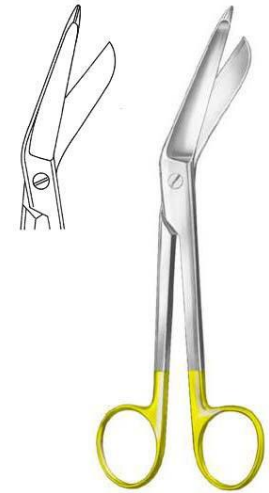

Lister
SLD-06-109-18
Bandage Scissors
18 cm,



Bruns
SLD-06-110-24
Plaster Scissors
24 cm,



Hopkins
SLD-06-111-20
Plaster Knife with wooden handle
20 cm,



Reiner
SLD-06-112-18
Plaster Knife
18 cm,



Reiner
SLD-06-113-18
Plaster Knife
18 cm,



Martin
SLD-06-114-21
Plaster Knife with wooden handle
21 cm,



Engel
SLD-06-115-14
Plaster Saw
15.5 cm,

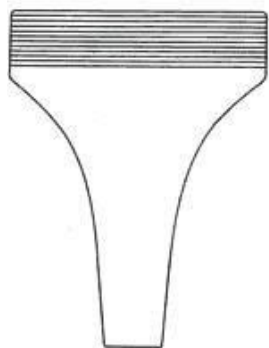

Hennig
SLD-06-116-28
Plaster Spreader
28 cm,

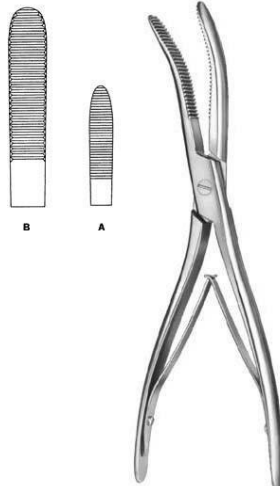

Wolff
SLD-06-117-18
Plaster Breaker
18 cm, 26.5 cm,



Gigli
SLD-08-101-01
Wire Saw Handle



De Martel
SLD-08-102-33
Wire Saw Guide
33 cm,



Crutchfield
SLD-08-103-01
Skull Traction Tong small pattern



SLD-08-104-01
Skull Traction Tong large pattern
22.5 cm,



Dahlgren
SLD-08-105-20
Cranial Rongeur
20 cm,



Olivecrona-Toennis
SLD-08-106-14
Clip Applying Forceps



McKenzie
SLD-08-107-19
Clip Applying Forceps
18.5 cm,



Olivecrona
SLD-08-108-18
Dura Dissector
18 cm,



Olivecrona
SLD-08-109-19
Dura Dissector
20 cm,



Milligan
SLD-08-110-21
Dura Dissector
21.5 cm,



Davis
SLD-08-111-21
Dura Dissector sharp
21.5 cm,



SLD-08-112-22
Dura Dissector
22 cm,



Davis
SLD-08-113-24
Dura Dissector
24.5 cm,



Love
SLD-08-114-19
Nerve Root Retractor
21.5 cm, 18 cm, 11 cm,



Olivecrona
SLD-08-115-18
Brain Spatula
18 cm,



Scoville
SLD-08-116-23
Nerve Root Retractor 8mm
23.5 cm,



Holsher
SLD-08-117-24
Nerve Root Retractor 8mm
23.5 cm,



Scoville
SLD-08-118-19
Nerve Root Retractor 7mm
16.5 cm,



Groningen
SLD-08-119-26
Nerve Hook
26.5 cm,



Groningen
SLD-08-120-26
Nerve Hook
26.5 cm,



Cushing
SLD-08-121-19
Nerve Hook blunt
19 cm,28 cm,

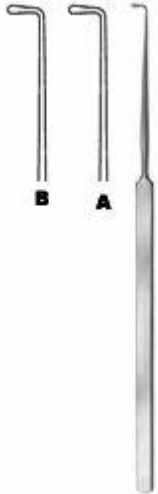

Cushing
SLD-08-122-19
Nerve Hook
19.5 cm,28 cm,



Smithwick
SLD-08-123-17
Nerve Hook
17 cm,21 cm,



Halle
SLD-08-125-20
Dura Knife
20 cm,



Adson
SLD-08-126-20
Dura Hook
20 cm,



Graham
SLD-08-127-16
Dura Hook blunt
16.5 cm,



Sachs
SLD-08-128-18
Dura Hook sharp
18 cm,



Toennis
SLD-08-129-15
Dura Hook sharp
14.5 cm,



Frazier
SLD-08-130-13
Dura Hook sharp
13 cm, 18 cm,



Krayenbuhl
SLD-08-131-01
Nerve and Vessel Hooklet
18.5 cm Fig. 1, 18.5 cm Fig. 2,

Neurosurgery



Cloward
SLD-08-132-16
 Lamina Spreader
 16 cm,

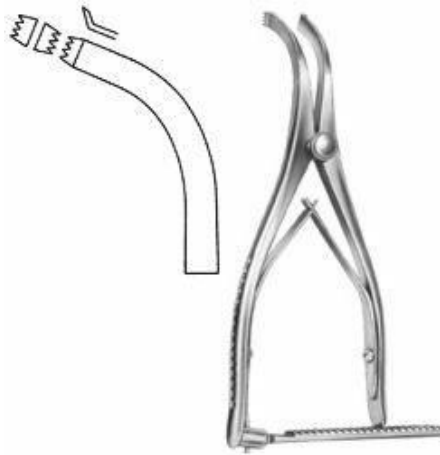

Inge
SLD-08-133-17
 Lamina Spreader
 16 cm,

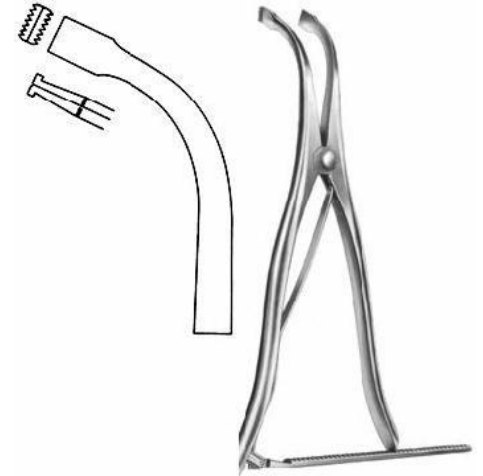

Inge
SLD-08-134-27
 Lamina Spreader
 25.5 cm,

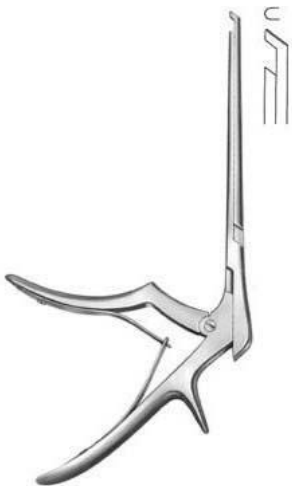

Ferris-Smith Kerrison
SLD-08-135-03
 Laminectomy Punch 3mm downwards cutting
 40 degree shaft length 180 mm

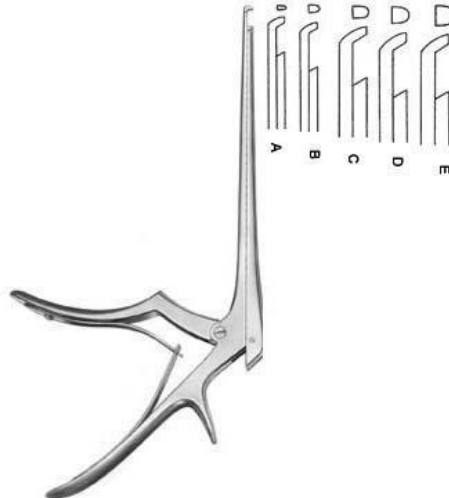

Ferris-Smith Kerrison
SLD-08-138-01
 Laminectomy Punch upwards cutting shaft
 length 180 mm
 1 mm, 2 mm, 3 mm, 4 mm, 5 mm, 6 mm,

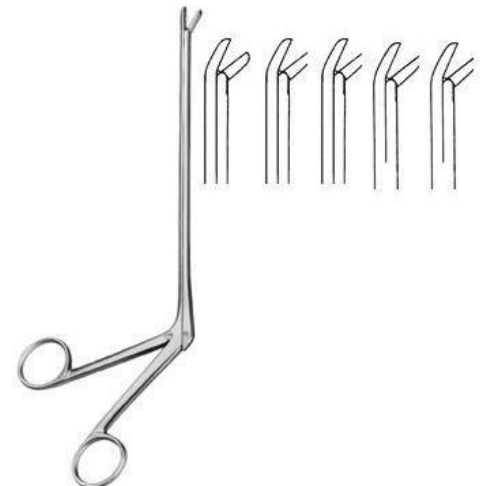

Cushing
SLD-08-139-01
 Laminectomy Rongeur jaw 2 x 10 to 4 x 10
 mm straight shaft length 180 mm

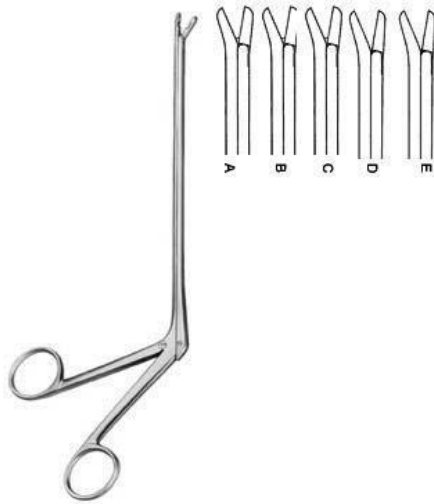

Cushing

SLD-08-140-01

Laminectomy Rongeur jaw 2 x 10 to 4 x 10 mm upwards 45 degree shaft length 120 mm



Ferris-Smith Kerrison

SLD-08-137-01

Laminectomy Punch
1 mm, 2 mm, 3 mm, 4 mm, 5 mm, 6 mm,

Cardiovascular



SLD-09-101-23
Bone Shear
23 cm,



SLD-09-102-22
Rib Shear
23 cm,



Gluck
SLD-09-103-22
Rib Shears
21 cm,



Giertz-Stille
SLD-09-104-27
Rib Shear
24.5 cm,



Lebsche
SLD-09-105-24
Sternum Chisel
24.5 cm,



SLD-09-106-01
Rib Retractor lateral blades 12 x 16 mm
spreading 95 mm
Size 1,

Cardiovascular



Finochietto, Infant
SLD-09-107-01

Rib Retractor lateral blades 15 x 15 mm
spreading 75 mm
Size 1,



Finochietto, Baby
SLD-09-108-01

Rib Retractor lateral blades 31 x 31 mm
spreading 100 mm
Size 1,



Finochietto
SLD-09-109-01

Rib Retractor lateral blades 40 x 45 mm
spreading 135 mm
Size 1,



Burford
SLD-09-110-01

Rib Retractor with two pairs of blades 47 x 62 mm + 65 x 62 mm, spreading 200 mm
Size 1,



Castaneda
SLD-09-111-01

Rib Retractor lateral blades 10,5 x 32 mm
spreading 65 mm
Size 1,



Finochietto (modif.)
SLD-09-112-01

Rib Retractor lateral blades 14 x 15 mm
spreading 120 mm
Size 1,

Cardiovascular



Haight

SLD-09-113-90

Rib Retractor lateral blades 30 x 30 mm
spreading 120 mm
Size 1,



Morse-Favaloro

SLD-09-114-01

Sternal Retractor 4 movable blades 17 x 22
mm spreading 160 mm Sternal Retractor
Size 1,



Morse

SLD-09-115-00

Sternal Retractor 4 movable blades 22 x 27
mm spreading 200 mm
Size 1,



Tuffier

SLD-09-116-02

Rib Retractor lateral blades 22 x 27 mm
spreading 200 mm
Size 1,

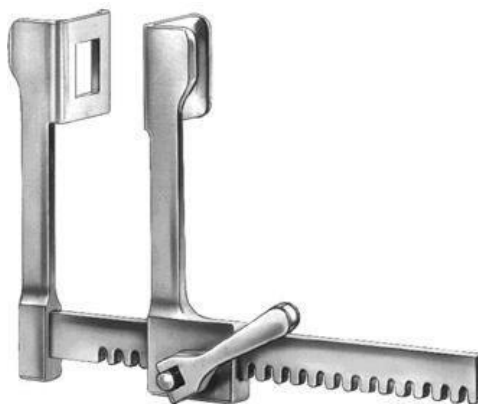

Finochietto, Baby

SLD-09-117-75

Rib Retractor lateral blades 14 x 15 mm
spreading 75 mm
Size 1,



Finochietto

SLD-09-118-01

Rib Retractor lateral blades 30 x 45 mm
spreading 150 mm
Size 1,

Cardiovascular



DeBakey
SLD-09-119-00
 Rib Retractor spreading 150 mm
 Size 1,



DeBakey
SLD-09-120-00
 Rib Retractor spreading 200 mm
 Size 1,



SLD-09-121-00
 Thoracic Retractor
 Size 1,



Sellors
SLD-09-122-19
 Rib Contractor
 20 cm,



Bailey-Baby
SLD-09-123-14
 Rib Contractor
 15.5 cm,



Bailey
SLD-09-124-16
 Rib Contractor
 20 cm,

Cardiovascular



Bailey-Gibbon
SLD-09-125-16
 Rib Contractor
 20 cm,



Allison
SLD-09-126-30
 Lung Spatula
 29.5 cm, 32.5 cm,



Price-Thomas
SLD-09-127-22
 Bronchus Clamp
 22 cm,

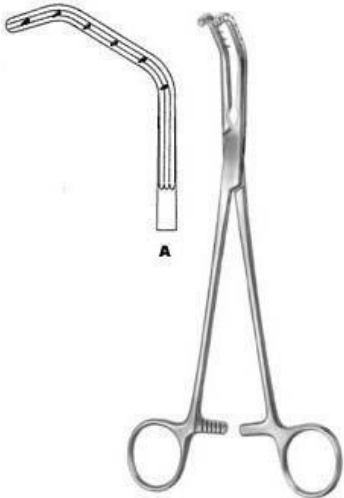

Price-Thomas
SLD-09-128-22
 Bronchus Clamp
 22 cm,

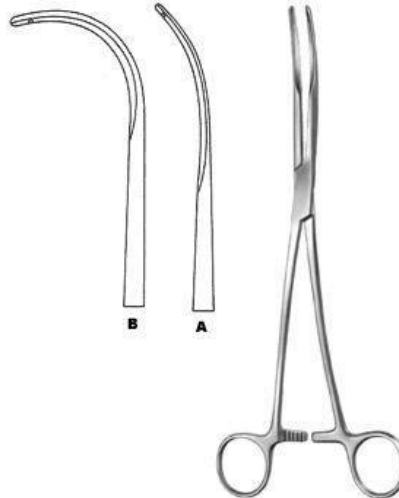

Semb
SLD-09-129-24
 Bronchus Clamp
 24.5 cm,

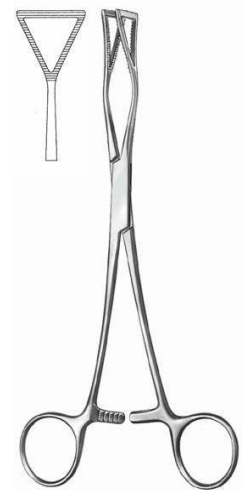

Lovelace
SLD-09-130-20
 Lung Grasping Forceps
 20.5 cm,

Cardiovascular

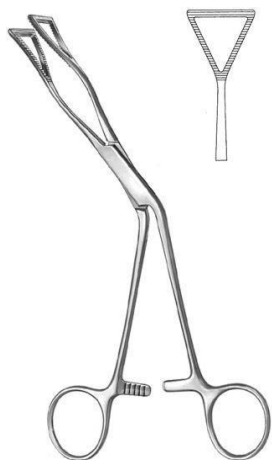

Lovelace
SLD-09-131-20
Lung Grasping Forceps
19 cm,



DeBakey-Satinsky
SLD-09-132-07
Bulldog Clamp
7 cm, 9 cm,



Glover
SLD-09-133-06
Bulldog Clamp
cm,

6



Santulli
SLD-09-134-07
Bulldog Clamp
7 cm,



Gregory, soft
SLD-09-135-09
Bulldog Clamp
9 cm, 11 cm,



Gregory
SLD-09-136-01
Bulldog Clamp
10.5 cm,

Cardiovascular

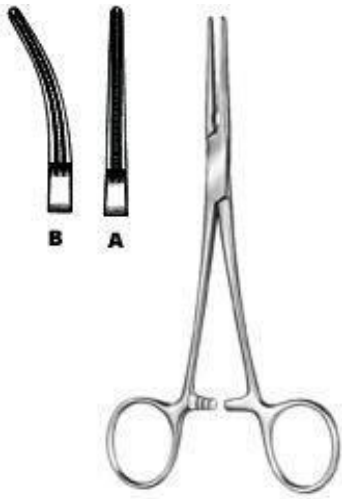

DeBakey-Rankin
SLD-09-137-16
 Haemostatic Forceps
 16 cm,



DeBakey-Mosquito
SLD-09-138-15
 Haemostatic Forceps
 15 cm,



Ochsner
SLD-09-139-23
 Aortic Clamp
 23.5 cm,



Diethrich
SLD-09-140-21
 Aortic Clamp
 22 cm,

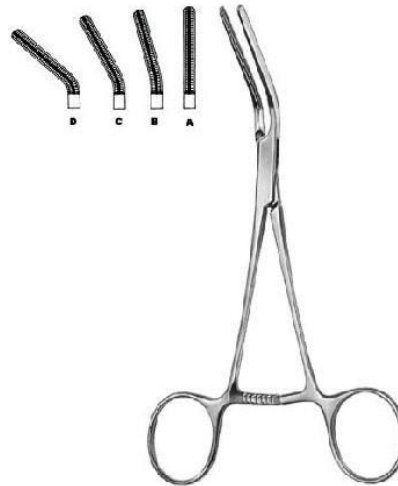

Dardik
SLD-09-141-00
 Multi purpose Vascular Clamp
 15 cm,



Dale
SLD-09-142-18
 Peripheral Vascular Clamp
 18 cm,

Cardiovascular

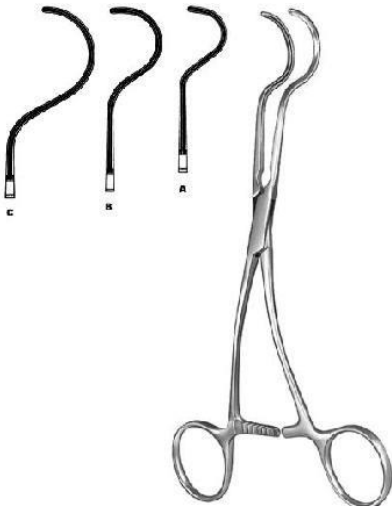

Dale
SLD-09-143-17
 Peripheral Vascular Clamp
 17.5 cm,

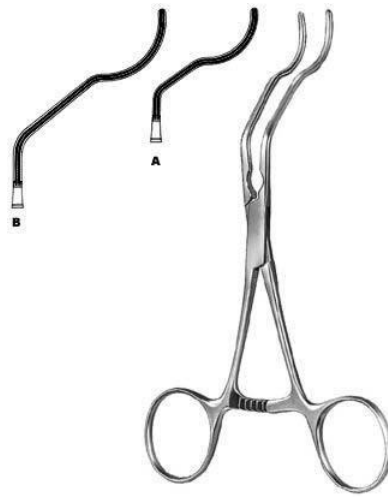

Gregory
SLD-09-144-14
 Profunda Clamp
 13 cm, 16 cm, 18 cm,

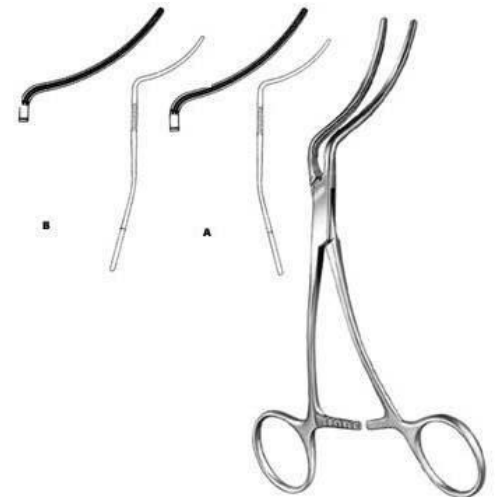

Martin
SLD-09-145-16
 Peripheral Vascular Clamp
 16.5 cm,



Husfeldt
SLD-09-146-18
 Peripheral Vascular Clamp
 17.5 cm,



Husfeldt
SLD-09-147-18
 Peripheral Vascular Clamp
 18 cm,



Husfeldt
SLD-09-148-17
 Peripheral Vascular Clamp
 17 cm,

Cardiovascular



DeBakey
SLD-09-149-16
 Vascular Forceps
 16 cm,



DeBakey
SLD-09-150-16
 Vascular Forceps
 16 cm,



DeBakey
SLD-09-151-16
 Vascular Forceps
 16 cm,

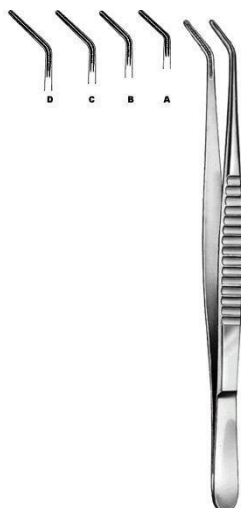

DeBakey
SLD-09-152-16
 Vascular Forceps
 16 cm,



DeBakey
SLD-09-153-16
 Vascular Forceps
 16 cm,



DeBakey
SLD-09-154-07
 Bulldog Clamp
 7.5 cm,

Cardiovascular



DeBakey
SLD-09-155-07
Bulldog Clamp
7.5 cm,



SLD-09-156-23
Applying Forceps
23.5 cm,



Glover
SLD-09-157-06
Bulldog Clamp
7 cm,



Glover
SLD-09-158-06
Bulldog Clamp
6.5 cm,

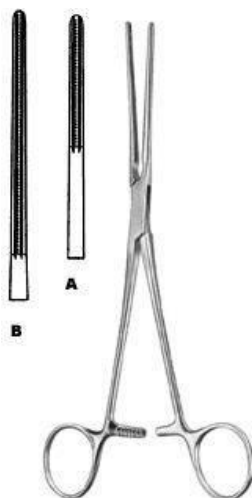

Potts
SLD-09-159-21
Coarctation Clamp
21 cm,

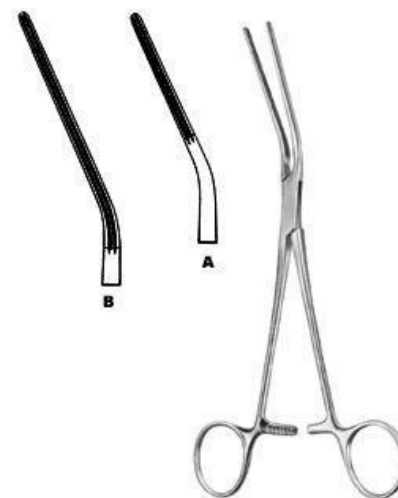

Potts
SLD-09-160-21
Coarctation Clamp
20.5 cm,

Cardiovascular

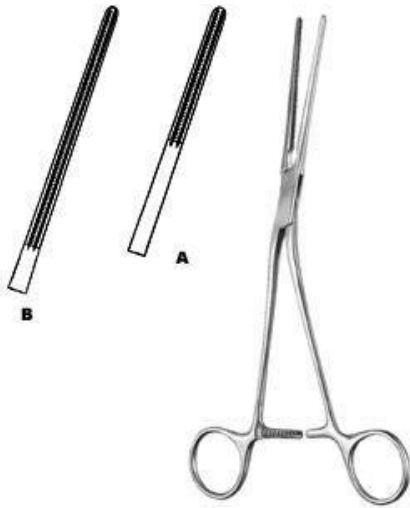

Potts
SLD-09-161-21
 Coarctation Clamp
 20.5 cm,



Potts
SLD-09-162-22
 Anastomosis Clamp
 21.5 cm,



Potts
SLD-09-163-22
 Anastomosis Clamp
 22 cm,

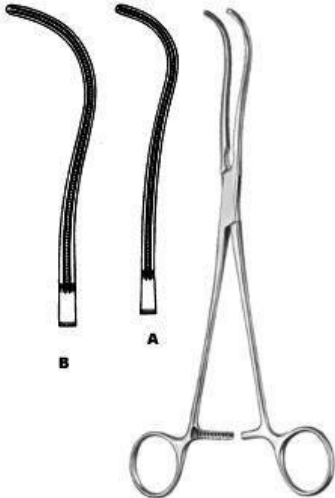

DeBakey
SLD-09-164-19
 Ligature Forceps
 19 cm,



DeBakey
SLD-09-165-16
 Peripheral Vascular Clamp
 16 cm,



DeBakey
SLD-09-166-19
 Peripheral Vascular Clamp
 16 cm,

Cardiovascular

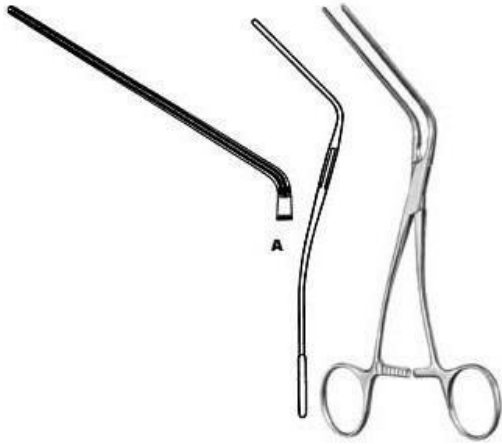

Leland-Jones
SLD-09-167-18
 Peripheral Vascular Clamp
 18 cm,



Bainbridge
SLD-09-168-15
 Multi purpose Vascular Clamp
 15 cm,



Bainbridge
SLD-09-169-15
 Multi purpose Vascular Clamp
 15 cm,

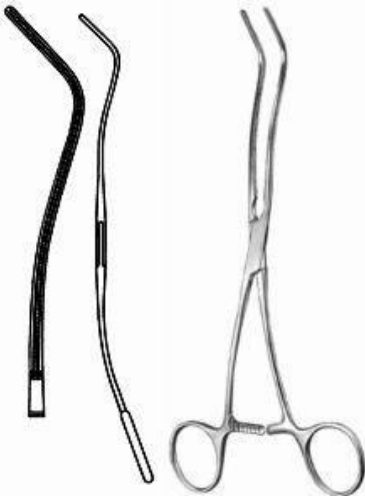

DeBakey
SLD-09-170-20
 Multi purpose Vascular Clamp
 20 cm,



DeBakey
SLD-09-171-26
 Aortic Aneurysm Clamp
 26 cm,



DeBakey
SLD-09-172-28
 Aortic Aneurysm Clamp
 28 cm,

Cardiovascular



DeBakey
SLD-09-173-30
Aortic Aneurysm Clamp
30 cm,



DeBakey
SLD-09-174-27
Aortic Clamp
27 cm,



DeBakey
SLD-09-175-24
Ligature Forceps
24.5 cm,



DeBakey
SLD-09-176-24
Ligature Forceps
24.5 cm,



DeBakey
SLD-09-178-25
Ligature Forceps
27 cm,

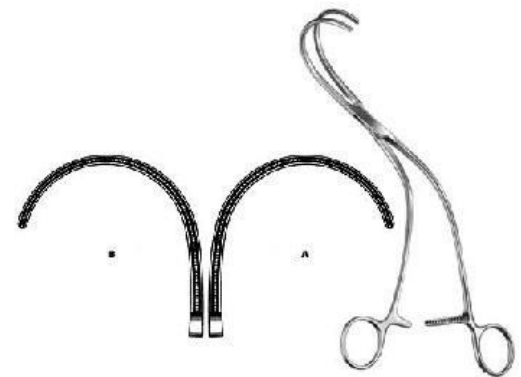

Weber
SLD-09-179-01
Aortic Clamp
24 cm,

Cardiovascular



Satinsky
SLD-09-180-20
 Tangential Occlusion Clamp
 22 cm,



Harken
SLD-09-181-01
 Auricle Clamp
 24.5 cm,



Lees
SLD-09-182-23
 Bronchus Clamp
 23 cm,



Lees
SLD-09-183-25
 Bronchus Clamp
 25 cm,



Lambert-Kay
SLD-09-184-21
 Anastomosis Clamp
 22.5 cm,



DeBakey
SLD-09-185-17
 Anastomosis Clamp
 16.5 cm,

Cardiovascular



Morris-DeBakey
SLD-09-186-18
 Aortic Clamp
 16.5 cm,



DeBakey-Bahnson
SLD-09-187-23
 Aneurysm Clamp
 23.5 cm,

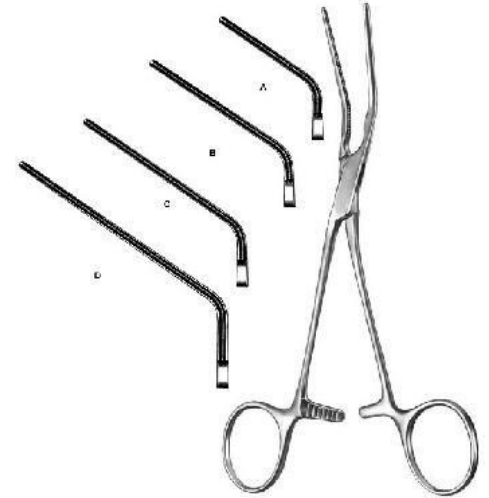

DeBakey
SLD-09-188-20
 Multi purpose Vascular Clamp
 18 cm,

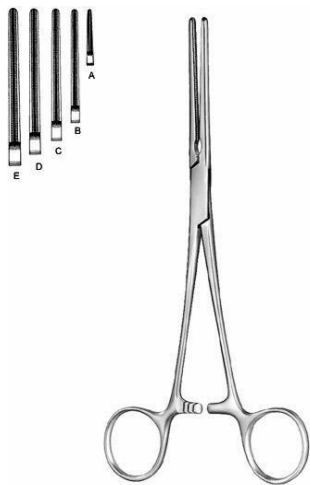

DeBakey-Mosquito
SLD-09-189-12
 Haemostatic Forceps
 12.5 cm,



DeBakey-Mosquito
SLD-09-190-12
 Haemostatic Forceps
 12.5 cm,



DeBakey
SLD-09-191-17
 Multi purpose Vascular Clamp
 17 cm,

Cardiovascular



DeBakey
SLD-09-192-16
Multi purpose Vascular Clamp
16.5 cm,

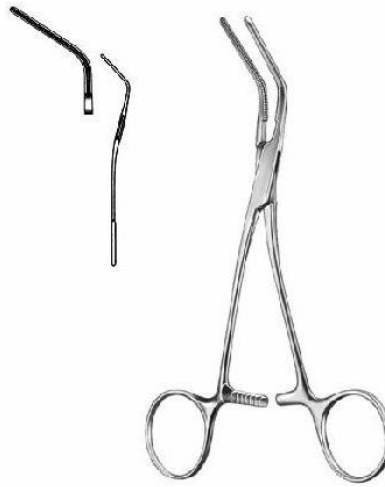

DeBakey
SLD-09-193-15
Multi purpose Vascular Clamp
16 cm,

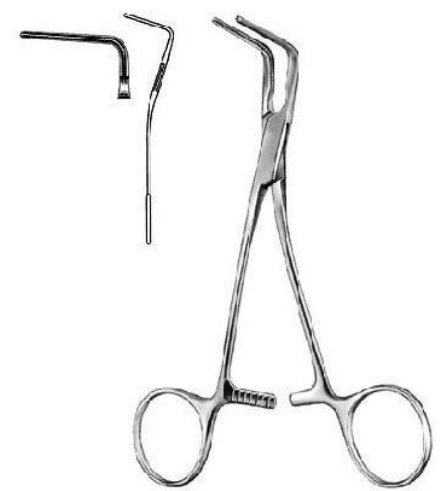

DeBakey
SLD-09-194-15
Multi purpose Vascular Clamp
16.5 cm,



DeBakey
SLD-09-195-17
Multi purpose Vascular Clamp
16.5 cm,



Glover
SLD-09-196-17
Multi purpose Vascular Clamp
17 cm,



Glover
SLD-09-197-17
Multi purpose Vascular Clamp
17.5 cm,

Cardiovascular

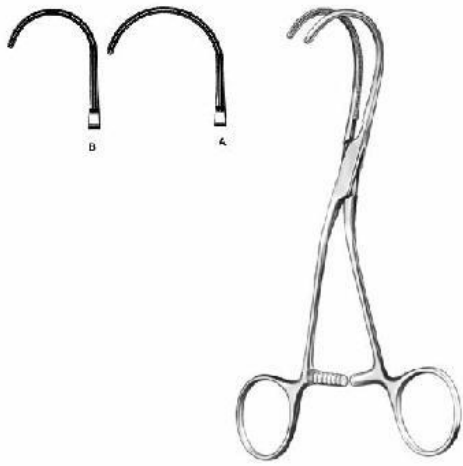

DeBakey
SLD-09-198-16
 Multi purpose Vascular Clamp
 16.5 cm,

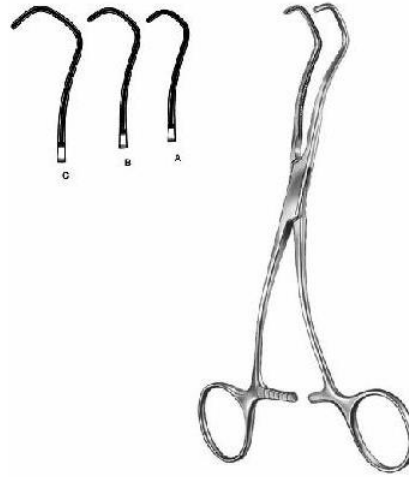

Derra
SLD-09-199-16
 Anastomosis Clamp
 16.5 cm Fig. 1, 17 cm Fig. 2, 18 cm Fig. 3,



DeBakey-Beck
SLD-09-200-17
 Anastomosis Clamp
 17 cm,



Cooley
SLD-09-201-16
 Vascular Forceps
 16 cm,

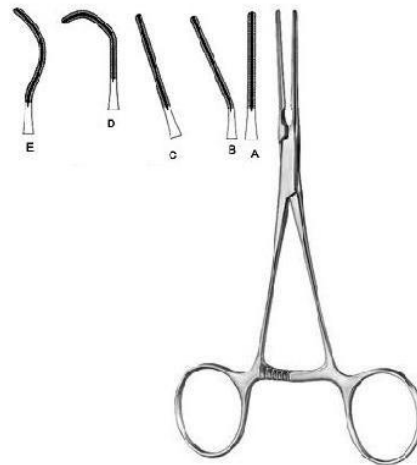

Cooley
SLD-09-202-01
 Pediatric Vascular Clamp
 14.5 cm,



Cooley
SLD-09-203-21
 Iliac Clamp
 22 cm,

Cardiovascular



Cooley
SLD-09-204-17
Anastomosis Clamp
17 cm,

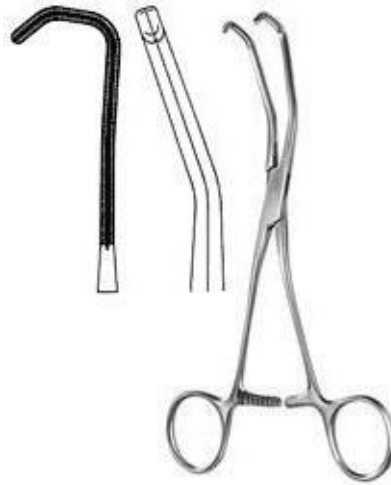

Cooley
SLD-09-205-17
Anastomosis Clamp
20 cm,



Cooley
SLD-09-206-16
Anastomosis Clamp
17 cm,



Cooley
SLD-09-207-15
Multi purpose Vascular Clamp
16 cm,



Cooley
SLD-09-208-17
Multi purpose Vascular Clamp
17 cm,



Cooley
SLD-09-209-17
Multi purpose Vascular Clamp
17 cm,

Cardiovascular



Cooley
SLD-09-210-17
 Multi purpose Vascular Clamp
 17.5 cm,

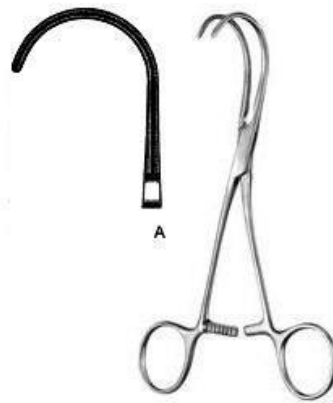

Cooley
SLD-09-211-16
 Multi purpose Vascular Clamp
 16.5 cm,



Cooley-Derra
SLD-09-212-16
 Anastomosis Clamp
 16.5 cm,



Cooley-Beck
SLD-09-213-17
 Anastomosis Clamp
 17 cm,

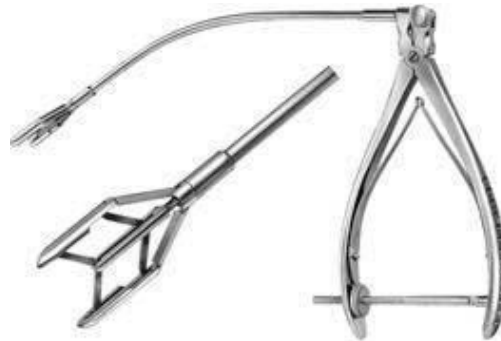

Cooley
SLD-09-214-00
 Aortic Dilator



Cooley
SLD-09-215-05
 Vascular Dilator
 13 cm 0,5 mm ?,

Cardiovascular



DeBakey
SLD-09-216-05
 Vascular Dilator
 19 cm 0,5 mm ?,



Martin
SLD-09-217-00
 Tunneling Set complete set with three shafts,
 two handles and 12 tips in storage case.



Hach
SLD-09-218-01
 Fasciotomy Knife with plastic handle
 30 cm,



SLD-09-219-18
 Intima Spatula
 18.5 cm,

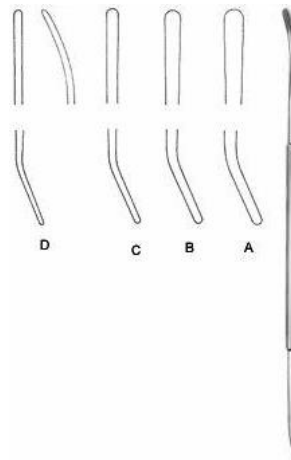

Robb
SLD-09-220-01
 Vascular Dissector
 24 cm Fig. 1 2,5 mm ?, 24 cm Fig. 2 2,0 mm
 ?,



Crile
SLD-09-221-20
 Nerve Hooklet
 20 cm,

Cardiovascular

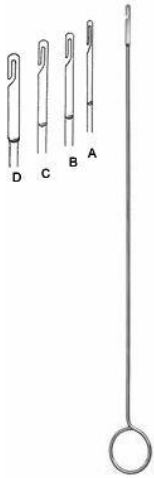

SLD-09-222-15
Ligature Catcher
26 cm 1,5 mm,



Subramanian-Miniature
SLD-09-223-15
Aortic Clamp 135 degree
15.5 cm,

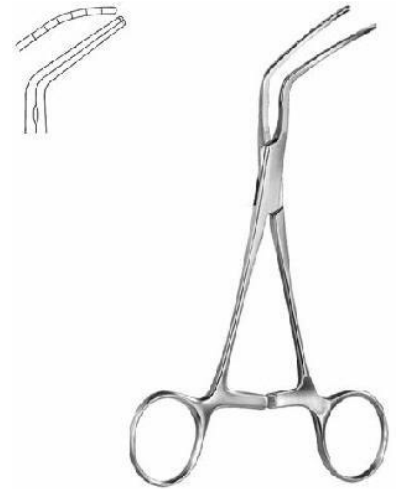

Subramanian
SLD-09-224-16
Aortic Clamp
16 cm,

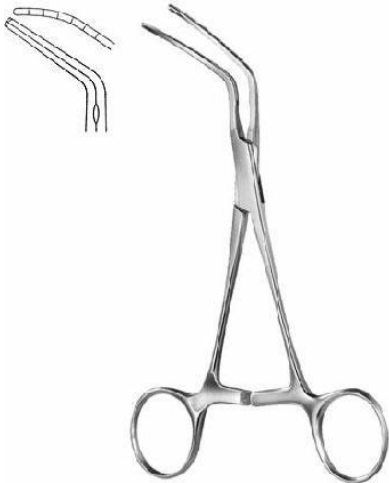

Subramanian
SLD-09-225-16
Aortic Clamp

13.5 cm Fig. 1, 13.5 cm Fig. 2, 14 cm Fig. 3,

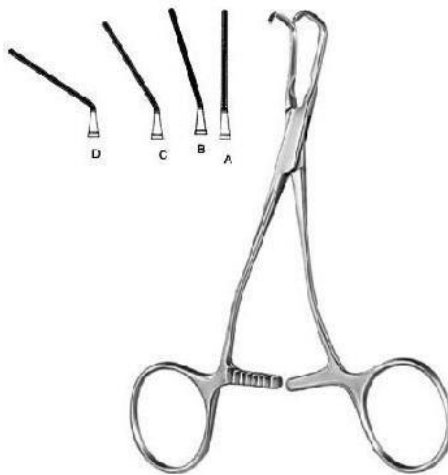

SLD-09-226-01
Pediatric Vascular Clamp



SLD-09-227-16
Pediatric Vascular Clamp
16.5 cm,



SLD-09-228-16
Pediatric Vascular Clamp
16 cm,

Ophthalmology



Barraquer (Colibri)
SLD-11-101-03
Barraquer
Size 1,



SLD-11-102-07
Bowman
Size 1,



SLD-11-103-06
Critchett
Size 1,



SLD-11-104-05
Smith
Size 1,



SLD-11-105-08
Clark
Size 1,



SLD-11-106-06
Graefe
Size 1,



SLD-11-107-08

Week
Size 1,



SLD-11-108-07

Arruga
Size 1,



SLD-11-109-07

Arruga
Size 1,



SLD-11-110-05

Murdock
Size 1,



Millenger

SLD-11-111-07

Mellinger Axenfeld
Size 1,



Millenger

SLD-11-112-07

Mellinger Axenfeld
Size 1,

Ophthalmology



Millenger
SLD-11-113-07
Mellinger
Size 1,



SLD-11-114-08
Lister Burch
Size 1,



Williams Eye Speculum
SLD-11-115-08
Williams
7 cm, 8.3 cm,



Lancaster
SLD-11-116-07
Lancaster
Size 1,



SLD-11-118-08
Ziegler
Size 1,



Mueller
SLD-11-120-07
Mueller
Size 1,

Ophthalmology



Jaeger Lid Plate
SLD-11-121-11
Jaeger
4", 20mm, 23mm,



VON GRAEFE Knife
SLD-11-122-03
Graefe
1, 2, 3, 4, 5,



SLD-11-123-01
Jaeger
Size 1,



SLD-11-124-13
Berens
Size 1,



ZIEGLER knife Needle
SLD-11-126-01
Ziegler
11.4 cm,



Castroviejo Cyclodialysis Spatula
SLD-11-127-12
Castroviejo
13.3 cm,



SLD-11-128-12
Wheeler
Size 1,



Castroviejo Cyclodialysis Spatula
SLD-11-129-05
Castroviejo
Size 1,



SLD-11-130-12
Dix
Size 1,



SLD-11-131-13
Dix
Size 1,



SLD-11-132-13
Dix
Size 1,



Castroviejo Caliper
SLD-11-133-07
Castroviejo
8.3 cm,



SLD-11-134-13
Connin Amsler
Size 1,



SLD-11-135-06
Dastoor
Size 1,



SLD-11-136-09
Holth
Size 1,



Wilder Lacrimal Dilator
SLD-11-137-03
Wilder
10.2 cm,



ZIEGLER Lacrimal Dilator
SLD-11-138-12
Ziegler
14 cm Double End,



Castroviejo Lacrimal Dilator
SLD-11-139-12
Castroviejo
14 cm,

Ophthalmology



SLD-11-140-78

Bowman
Size 1,



SLD-11-141-07

Graefe
Size 1,



SLD-11-142-07

Graefe
Size 1,



SLD-11-143-07

Graefe
Size 1,



SLD-11-144-07

Graefe
Size 1,



SLD-11-145-07

Fischer
Size 1,

Ophthalmology



SLD-11-146-07
Barraquer Katzin
Size 1,



SLD-11-147-07
Troutman
Size 1,



SLD-11-148-07
Barraquer
Size 1,



SLD-11-149-07
Barraquer
Size 1,



SLD-11-150-09
McCullough
Size 1,



SLD-11-151-09
McCullough
Size 1,

Ophthalmology



SLD-11-152-10
Jameson
Size 1,



SLD-11-153-10
Jameson
Size 1,



SLD-11-154-10
Bonaccolto
Size 1,



SLD-11-155-10
Bonaccolto
Size 1,



SLD-11-156-10
Dastoor
Size 1,



SLD-11-157-10
Dastoor
Size 1,



SLD-11-158-05
Bishop Harman
Size 1,



SLD-11-159-08
Bishop Harman
Size 1,



SLD-11-160-05
Bishop Harman
Size 1,



SLD-11-161-08
Bishop Harman
Size 1,



SLD-11-162-07
Mod Bonn
Size 1,



SLD-11-163-07
Mod Bonn
Size 1,

Ophthalmology



SLD-11-164-10
Mod Bonn
Size 1,



SLD-11-165-10
Mod Bonn
Size 1,



SLD-11-166-10
Mod Bonn
Size 1,



SLD-11-167-10
Mod Bonn
Size 1,



SLD-11-168-10
Prince
Size 1,



SLD-11-169-10
Prince
Size 1,

Ophthalmology



SLD-11-170-20
Berke
Size 1,



SLD-11-171-08
Troutman
Size 1,



SLD-11-172-05
Barraquer
Size 1,



SLD-11-173-11
Elsching
Size 1,



SLD-11-174-11
Graefe
Size 1,



SLD-11-175-09
Lester
Size 1,

Ophthalmology



SLD-11-176-09
Castroviejo
Size 1,



SLD-11-178-09
Castroviejo
Size 1,



SLD-11-179-09
Barraquer
Size 1,



SLD-11-180-10
Green
Size 1,



SLD-11-181-07
Gill Arruga
Size 1,



SLD-11-182-01
Castroviejo
Size 1,

Ophthalmology



SLD-11-183-05
Castroviejo
Size 1,



SLD-11-184-10
Moorfield
Size 1,



SLD-11-185-07
St Martin
Size 1,



SLD-11-186-10
Mod Tubingen
Size 1,



SLD-11-187-10
McPherson
Size 1,



SLD-11-188-10
McPherson
Size 1,

Ophthalmology



SLD-11-189-09
Ayer
Size 1,



SLD-11-190-09
Ayer
Size 1,



SLD-11-191-09
Desmarres
Size 1,



SLD-11-192-10
Snellen
Size 1,



SLD-11-1193-11
Knapp Luer
Size 1,



SLD-11-194-28
Scheie
Size 1,

Ophthalmology



SLD-11-195-45
Mod Tubingen
Size 1,



SLD-11-196-00
Elliot
Size 1,



SLD-11-197-09
Beer
Size 1,



SLD-11-198-10
Barraquer



SLD-11-199-09
Douglas
Size 1,



SLD-11-200-09
Gradle
Size 1,

Ophthalmology



SLD-11-177-09
Castroviejo
Size 1,



SLD-11-119-07
Mueller
Size 1,

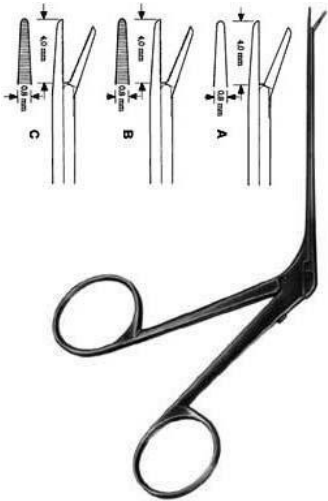

SLD-12-101-01

Micro Ear Forceps shaft length 80mm,
smooth straight, serrated straight

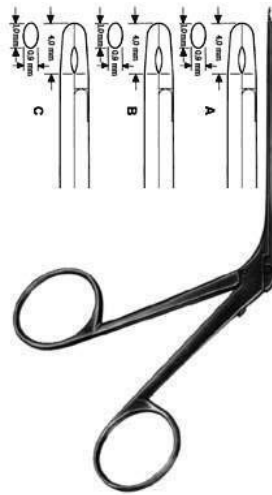

SLD-12-102-01

Micro Ear Forceps shaft length 80mm,
straight, bent upwards

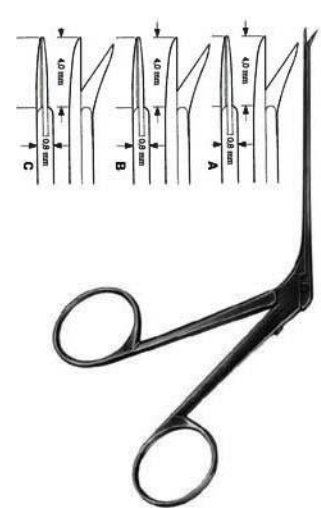

Bellucci

SLD-12-103-01

Micro Ear Scissors shaft length 80 mm



McGee

SLD-12-104-11

Wire Bending Forceps Wire Bending Forceps
shaft length 80 mm



House-Dieter

SLD-12-105-01

Malleus Nipper shaft length 80 mm



Fuller

SLD-12-106-01

Introducing Forceps shaft length 80 mm

Schuknecht
SLD-12-107-02
Rotary Knife

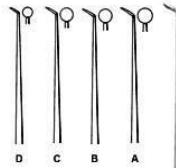

Barbara
SLD-12-109-01
Micro Ear Needle 0,3mm to 2,5mm
16 cm,

Rosen

SLD-12-108-01

Circular Cut Knife

15 cm Fig. 1 3mm?, 15 cm Fig. 2 2,8mm?, 15
cm Fig. 3 2,6mm?, 15 cm Fig. 4 2mm?, 15 cm
Fig. 5 1,6mm?, 15 cm Fig. 6 1,4mm?, 15 cm
Fig. 7 1,0mm?,

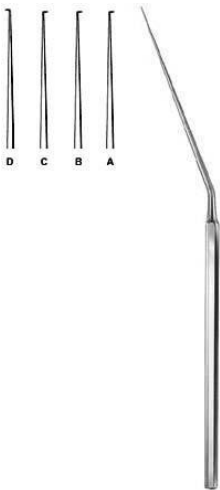

SLD-12-110-01
Micro Ear Hook 0,3mm to 1,0mm
15.5 cm,

SLD-12-111-06
Micro Ear Hook 0,3mm to 3,0mm, 25, 45, 90
degree

House
SLD-12-112-01
Micro Measuring Rod
15.5 cm 3,5mm, 15.5 cm 4,0mm, 15.5 cm
4,5mm, 15.5 cm 5,0mm,



House
SLD-12-113-01
 Micro Curette
 14.5 cm,



Hartmann
SLD-12-114-03
 Ear Specula, Set
 3.6 cm Fig. 0, 3.6 cm Fig. 1, 3.6 cm Fig. 2, 3.6 cm Fig. 3, 3.6 cm Fig. 4,



Zollner
SLD-12-115-00
 Ear Specula, Set
 3.8 cm,



Farrior
SLD-12-116-01
 Ear Speculum
 3.6 cm,



Martin-Alloy
SLD-12-117-12
 Tuning Fork
 c2 512,



Hartmann
SLD-12-118-10
 Tuning Fork
 c 128,



Lucae
SLD-12-119-10
 Tuning Fork
 c 128,



Hartmann
SLD-12-120-10
 Tuning Fork
 c 128,



Hartmann
SLD-12-121-11
 Tuning Fork
 c 256,

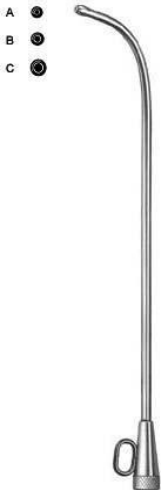

Hartmann
SLD-12-122-01
 Ear Catheter
 15 cm,



Troeltsch (Wilde)
SLD-12-123-11
 Ear Forceps
 10.5 cm,



Troeltsch (Wilde)
SLD-12-124-12
 Ear Forceps
 11 cm,

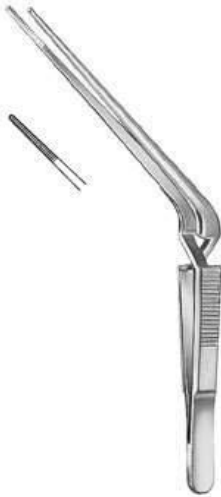

Troeltsch (Wilde)
SLD-12-125-13
Ear Forceps
12.5 cm,



Grunwald
SLD-12-126-14
Ear Forceps
14.5 cm,



Jansen
SLD-12-127-16
Ear Forceps
16 cm, 21.5 cm,

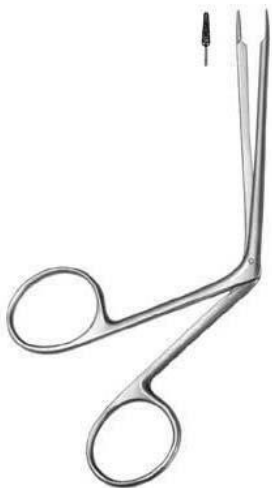

Littauer
SLD-12-128-12
Ear Polypus Forceps
10 cm,



Hartmann
SLD-12-129-12
Ear Polypus Forceps
12 cm,



Hartmann
SLD-12-130-14
Ear Polypus Forceps
12 cm,



Hartmann-Wullstein
SLD-12-131-08

Ear Polypus Forceps shaft length 85mm



Citelli
SLD-12-132-17

Mastoid Rongeur 3mm cut



Beyer
SLD-12-133-19

Mastoid Rongeur 2mm cut



Beyer
SLD-12-134-14

Mastoid Rongeur 1mm cut



Langenbeck
SLD-12-135-13

Ear Curette
13 cm,



Shapleigh
SLD-12-136-01

Ear Curette
15 cm,



Buck
SLD-12-137-02
Ear Curette
17 cm,



Jansen
SLD-12-138-15
Ear Scoop
17 cm,



Gross
SLD-12-139-12
Ear Scoop/Hook
13 cm,



Weber-Loch
SLD-12-140-01
Foreign Body Instrument
16.5 cm,



Billeau
SLD-12-141-01
Ear Loop
16 cm,



Zaufal
SLD-12-142-16
Foreign Body Lever
15 cm,



Wagner

SLD-12-143-01

Ear Hooklet

14 cm Fig. 1, 14 cm Fig. 2, 14 cm Fig. 3, 14 cm Fig. 4,



Day

SLD-12-144-01

Ear Hooklet

17 cm,



Poltzer

SLD-12-145-16

Tympanum Needle

15.5 cm,



Lucae

SLD-12-146-18

Tympanum Needle

17.5 cm,



Lempert

SLD-12-147-20

Micro Ear Periosteal Elevator

20.5 cm,



Lempert

SLD-12-148-17

Micro Ear Periosteal Elevator

18 cm,

0 0 0 0 0
E D C B A



Lempert
SLD-12-149-10
Ear Scoop
21.5 cm,



Ear Syringe
SLD-12-150-00
Ear Syringe
50 ml, 100 ml,

Rhinology



Goldsmith (Thudichum)
SLD-13-101-01
 Nasal Speculum
 6.5 cm,

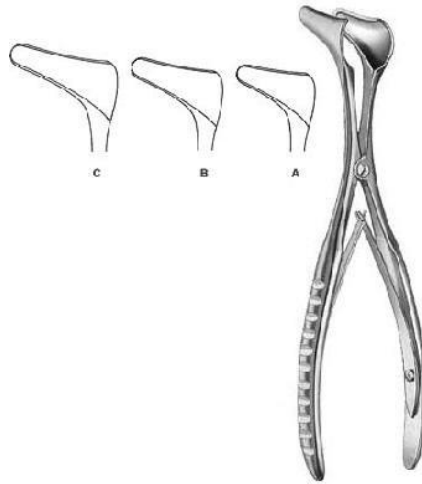

Hartmann-Halle
SLD-13-102-01
 Nasal Speculum
 15.5 cm,



Martin
SLD-13-103-13
 Nasal Speculum
 13 cm,



Martin
SLD-13-104-13
 Nasal Speculum
 12.5 cm,



Tieck-Halle
SLD-13-105-13
 Nasal Speculum
 13 cm,

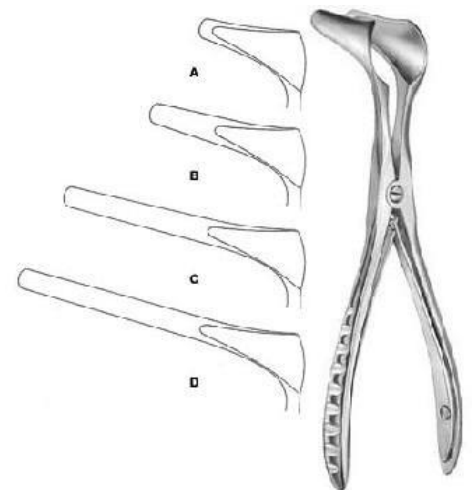

Killian
SLD-13-106-01
 Nasal Speculum
 13 cm,



Modell Wien
SLD-13-107-14
 Nasal Speculum
 13.5 cm,

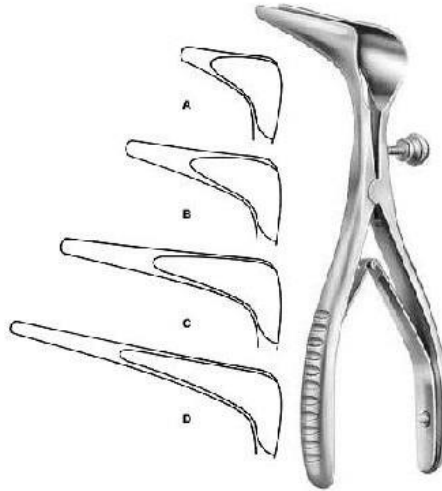

Cottle
SLD-13-108-35
 Nasal Speculum
 13.5 cm, 14.5 cm,



Cottle
SLD-13-109-45
 13.5 cm,



Cottle
SLD-13-110-15
 Nasal Tampon Forceps
 14.5 cm,



Troeltsch
SLD-13-111-18
 Nasal Tampon Forceps
 18 cm,



Grunwald (Jansen)
SLD-13-112-20
 Nasal Tampon Forceps
 21.5 cm,



Lubet-Barbon
SLD-13-113-20
 Nasal Tampon Forceps
 18.5 cm,



Lubet-Barbon
SLD-13-114-20
 Nasal Tampon Forceps
 18.5 cm,



Killian
SLD-13-115-16
 Septum Forceps
 16 cm,



Takahashi
SLD-13-116-12
 Ethmoid Bone Forceps
 19 cm,

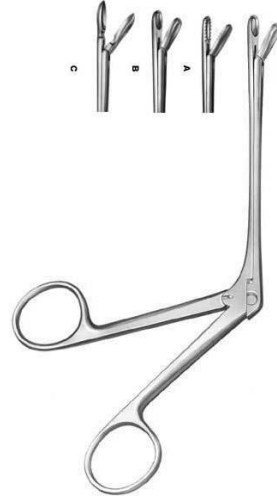

Watson-Williams
SLD-13-117-10
 Ethmoid Bone Forceps
 19 cm,

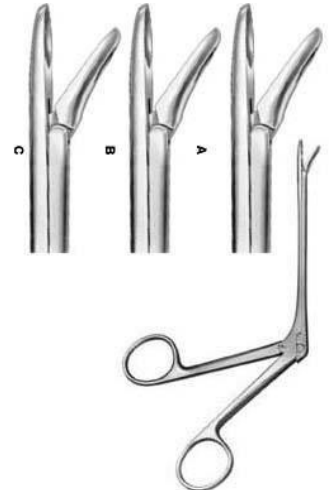

Weil-Blakesley
SLD-13-118-01
 Nasal Cutting Forceps
 12 cm,

Rhinology

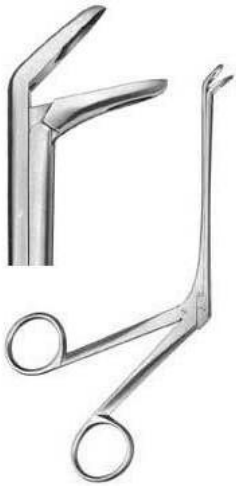

Weil-Blakesley
SLD-13-119-01

Ethmoid Bone Forceps shaft length 120mm

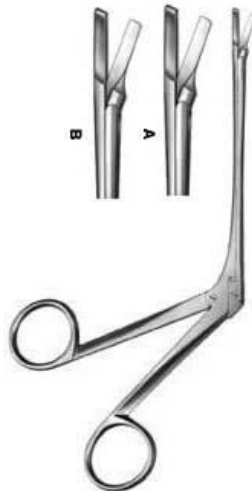

Struycken
SLD-13-120-01

Nasal Cutting Forceps
19 cm,



Hartmann
SLD-13-121-01

Nasal Cutting Forceps
19 cm,



Schmeden
SLD-13-122-12

Nasal Cutting Forceps
19 cm,



Ferris-Smith-Kerrison
SLD-13-123-17

Sphenoid Bone Punch
18 cm,

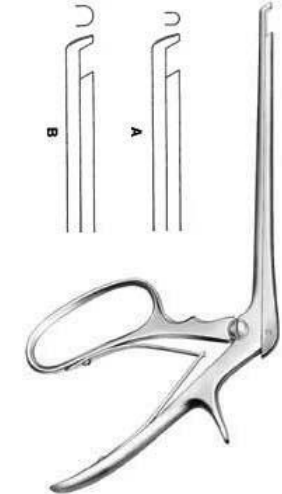

Ferris-Smith-Kerrison
SLD-13-124-03

Sphenoid Bone Punch
18 cm,

Rhinology



Kerrison
SLD-13-125-00
 Antrum Punch
 3 1/4",

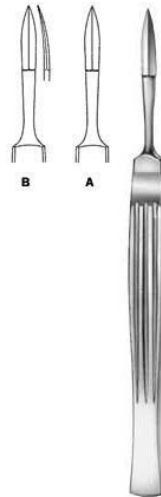

Joseph
SLD-13-126-01
 Rhinoplastic Knife
 15 cm,



Fomon
SLD-13-127-16
 Rhinoplastic Knife
 16.5 cm,



Converse
SLD-13-128-16
 Rhinoplastic Knife
 16 cm,



Cottle
SLD-13-129-15
 Rhinoplastic Knife
 14 cm,



Freer
SLD-13-130-15
 Mucosa Knife
 16.5 cm,



McKenty
SLD-13-131-04
Septum Elevator
15 cm,



Halle
SLD-13-132-16
Septum Elevator
16 cm,



Joseph
SLD-13-133-16
Septum Elevator
16 cm,



Freer
SLD-13-134-20
Septum Elevator
19 cm,

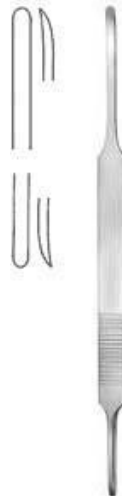

McKenty
SLD-13-135-22
Septum Elevator
20.5 cm,



Ballenger-Hajek
SLD-13-136-19
Septum Elevator
19 cm,



Cottle
SLD-13-137-22
Septum Elevator
23 cm,



Masing
SLD-13-138-21
Periosteal Elevator
19.5 cm,

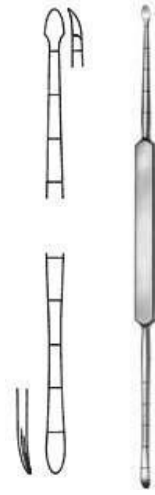

Cottle
SLD-13-139-21
Periosteal Elevator
22 cm,



Joseph
SLD-13-140-16
Periosteal Elevator
18 cm,



Freer
SLD-13-141-15
Septum Gouge
15 cm,



Killian
SLD-13-142-16
Septum Gouge
cm,



Killian-Claus
SLD-13-143-16
Septum Gouge
16 cm,



Cottle
SLD-13-144-04
Osteotome
18.5 cm,



Cottle
SLD-13-145-06
Osteotome
18.5 cm,



Cottle
SLD-13-146-16
Osteotome
18.5 cm,



Walter
SLD-13-147-03
Gouge
19 cm,



Fomon
SLD-13-148-04
Chisel
16 cm,

Rhinology

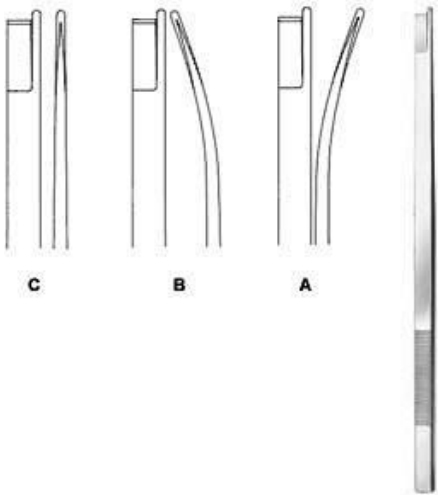

Neivert-Anderson
SLD-13-149-01
 Osteotome
 20.5 cm,

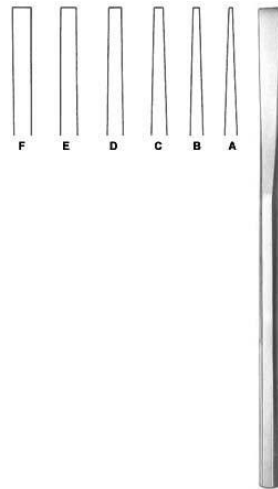

Sheehan
SLD-13-150-01
 Osteotome
 15 cm,

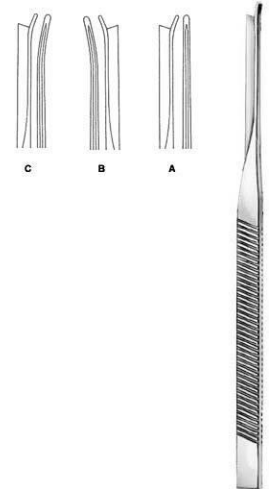

Silver
SLD-13-151-01
 Rhinoplastic Chisel
 18 cm,



Parkes
SLD-13-152-01
 Osteotome
 16 cm,

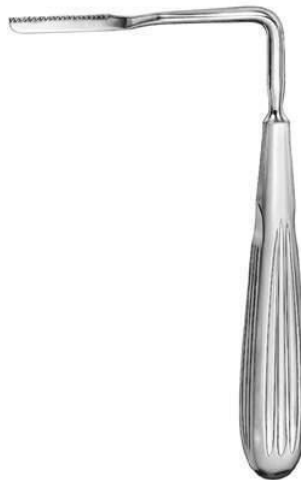

Joseph
SLD-13-153-20
 Nasal Saw
 17 cm,

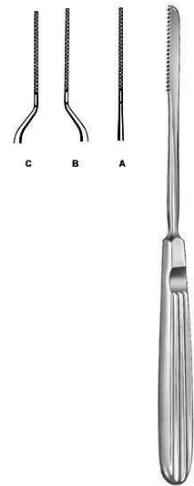

Joseph
SLD-13-154-00
 Nasal Saw
 19 cm,



Maltz
SLD-13-155-18
 Nasal Rasp
 17.5 cm,

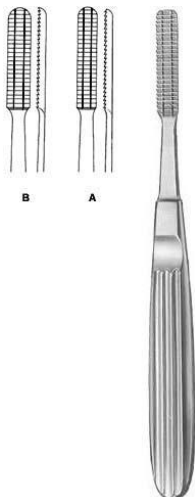

Maltz
SLD-13-156-01
 Nasal Rasp
 17 cm,

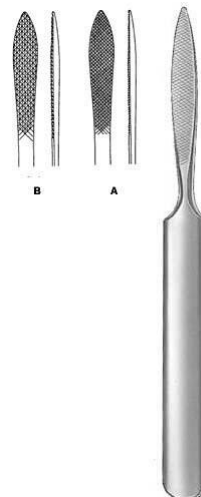

Joseph
SLD-13-157-01
 Bone File
 16 cm,



Cottle
SLD-13-158-21
 Nasal Rasp
 20.5 cm,

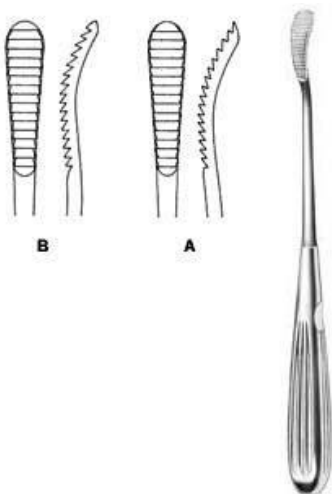

Aufricht
SLD-13-159-21
 Glabella Rasp
 21 cm,

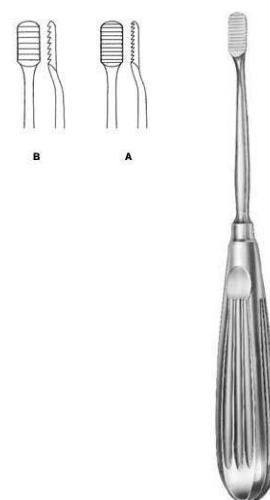

Lewis
SLD-13-160-18
 Nasal Rasp
 19 cm,

Rhinology



Lewis
SLD-13-161-18
Nasal Rasp
19 cm,



Fomon
SLD-13-162-01
Bone File
20.5 cm,



Cottle
SLD-13-163-01
Nasal Hook
17 cm,

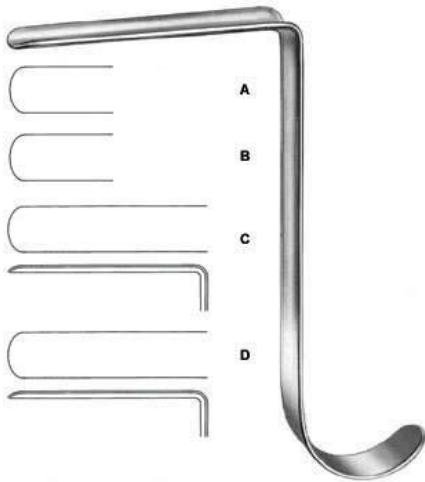

Converse
SLD-13-164-01
Nasal Retractor
9 cm,



Converse
SLD-13-165-12
Alar Hooklet
11.5 cm,



Freer
SLD-13-166-15
Mucosa Hooklet
15 cm,



Joseph
SLD-13-167-02
 Mucosa Hooklet
 16.5 cm,

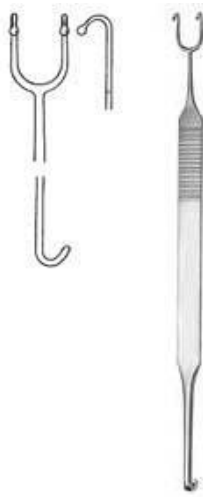

Cottle-Neivert
SLD-13-168-20
 Alar Hooklet
 19.5 cm,



Cottle
SLD-13-169-15
 Saddle Hook
 14 cm,



Kressner
SLD-13-170-20
 Septum Forceps
 21 cm,

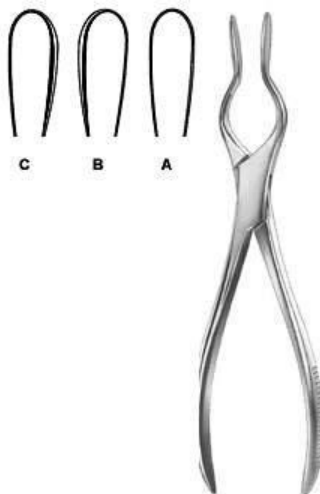

Cottle-Walsham
SLD-13-171-01
 Septum Straightening Forceps
 23 cm,



Asch
SLD-13-172-23
 Septum Straightening Forceps
 22.5 cm,



Ogura
SLD-13-13-11
Skin Grasping Forceps
11 cm,

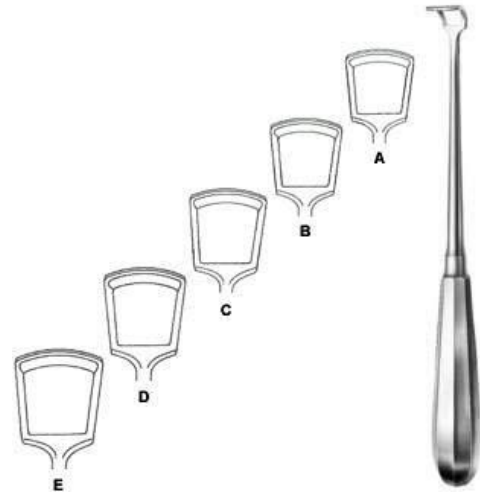

Beckmann
SLD-13-174-01
Adenoid Curette
22.5 cm,

Oral Instruments



Terry
SLD-14-101-16
 Elevator
 17 cm,



Terry
SLD-14-102-00
 Periosteal Elevator
 18 cm,

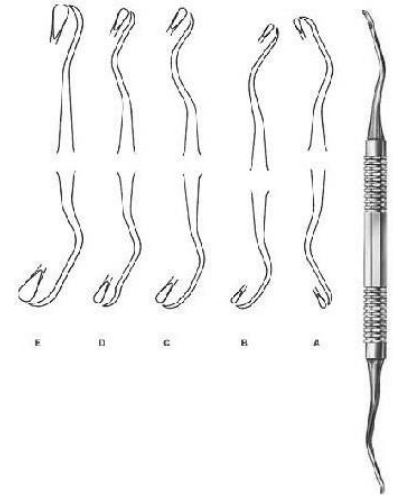

SLD-14-103-01
 Sinus Lift Curette
 18 cm, 17.5 cm, 18.5 cm, 19 cm, 16 cm, 15 cm, 17 cm,



Heister
SLD-14-104-13
 Mouth Gag
 13 cm,



Molt
SLD-14-105-11
 Mouth Gag
 11 cm,



Denhart
SLD-14-106-12
 Mouth Gag
 13 cm,

Oral Instruments

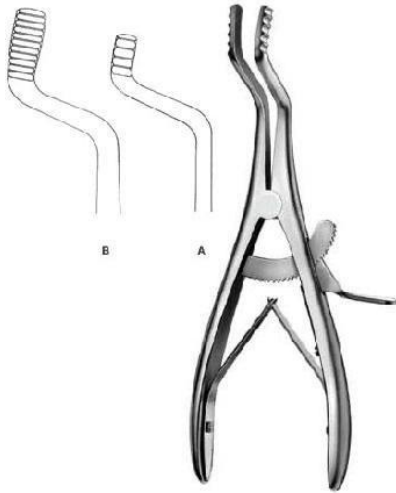

Roser-Konig
SLD-14-107-16
Mouth Gag
16 cm,

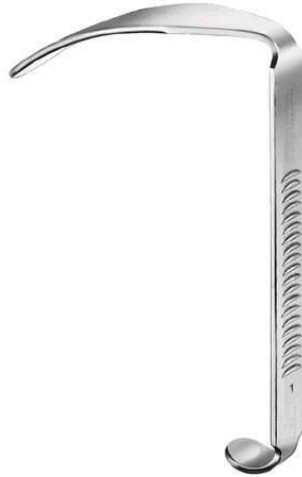

Roser-Knig
SLD-14-108-16
Mouth Gag
13.5 cm,



Jennings
SLD-14-109-09
Mouth Gag
10.5 cm,



Oringer
SLD-14-110-00
Lip and Cheek Retractor
9.5 cm, 10 cm, 10.5 cm, 11 cm,



Martin-Simplex
SLD-14-111-11
Cheek Retractor
10.5 cm,



SLD-14-112-14
Vestibulum Retractor
14 cm,

Oral Instruments



Sternberg

SLD-14-113-14

Lip and Cheek Retractor
14 cm,

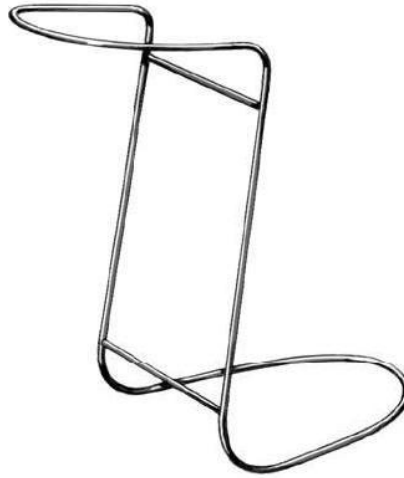

Obwegeser

SLD-14-114-12

Cheek Retractor
12 cm,



Cawood-Minnesota

SLD-14-115-15

Cheek Retractor
cm,

15



SLD-14-116-00

Cheek Retractor
14.5 cm,



Hartmann

SLD-14-117-15

Tongue Depressor
15 cm,



Tobold

SLD-14-118-14

Tongue Depressor
15 cm,

Oral Instruments



Tobold
SLD-14-119-14
Tongue Depressor
14.5 cm,



BC14-120-16
Tongue Spatula
16 cm,



SLD-14-121-15
Tongue Spatula
15 cm,



Martin
SLD-14-122-18
Tongue Spatula
18.5 cm,



Doyen
SLD-14-123-18
Tongue Spatula
13.5 cm,



Bruennings
SLD-14-124-19
Tongue Spatula
19 cm,

Oral Instruments



Collin
SLD-14-125-17
Tongue Holding Forceps
17 cm,



Young
SLD-14-126-17
Tongue Holding Forceps
15 cm,



Obwegeser
SLD-14-127-40
Soft Tissue Retractor
21.5 cm,



Obwegeser
SLD-14-128-22
Nasal Spine Retractor
22 cm,



Obwegeser
SLD-14-129-22
Ramus Retractor
22 cm,



Obwegeser
SLD-14-130-16
Chin Retractor
16.5 cm,

Oral Instruments



Obwegeser
SLD-14-131-18
Channel Retractor
17 cm,



SLD-14-132-01
Retractor
18.5 cm,



SLD-14-133-01
Periosteal Elevator
18 cm,



Obwegeser
SLD-14-134-06
Periosteal Elevator
17.5 cm,



Obwegeser
SLD-14-135-21
Elevator
20.5 cm,



Gillies
SLD-14-136-21
Zygoma Elevator
20 cm,

Oral Instruments



Obwegeser
SLD-14-137-21
Elevator
20.5 cm,



Rowe
SLD-14-138-01
Disimpaction Forceps
22.5 cm,



Rowe
SLD-14-139-01
Disimpaction Forceps
22.5 cm,



Dingmann
SLD-14-140-21
Zygoma Elevator
21 cm,



Dingmann-Wilk
SLD-14-141-19
Retractor
20 cm,



Jeter-Van Sickels
SLD-14-142-01
Bone Holding Forceps
18 cm,

Oral Instruments



Keen

SLD-14-143-01

Bone Holding Forceps
17.5 cm,



Steinhauser

SLD-14-144-01

Bone Holding Forceps
13 cm,



Wolford

SLD-14-145-25

Bone Holding Forceps
25 cm,



Salyer

SLD-14-146-16

Bone Holding Forceps
16 cm,



Bauer

SLD-14-147-00

Osteotome
20.5 cm,



Bauer

SLD-14-148-00

Osteotome
20.5 cm,

Oral Instruments



Epker-Bauer
SLD-14-149-01
Osteotome
17.5 cm,



Dautrey-Munro
SLD-14-150-04
Osteotome
16 cm,

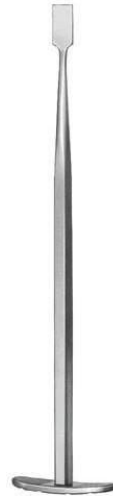

Dunn-Dautrey
SLD-14-151-04
Osteotome
16.5 cm,



Dunn-Dautrey
SLD-14-152-01
Osteotome
17 cm,



Epker
SLD-14-153-04
Osteotome
18 cm,



Hargis
SLD-14-154-19
Anterior Border Stripper
19 cm,

Oral Instruments



Hargis
SLD-14-155-01
Periosteal Elevator
23 cm,



Hargis
SLD-14-156-18
Periform Rim Retractor
18.5 cm,



Hargis
SLD-14-157-22
Pterygoid Osteotome
22 cm,



Smith
SLD-14-158-01
Sagittal Split Separator
17 cm,



Terry
SLD-14-159-16
Mandibular Retractor
16.5 cm,



Terry
SLD-14-160-24
Ramus Pusher
24 cm,

Oral Instruments



Terry
SLD-14-161-00
Occlusal Wedge



Steinhauser
SLD-14-162-18
Elevator
18.5 cm,



Steinhauser
SLD-14-163-07
Ramus Osteotome
17 cm,



Steinhauser
SLD-14-164-07
Chisel
19 cm,



Steinhauser
SLD-14-165-01
Periosteal Elevator
16 cm,



Steinhauser
SLD-14-166-16
Steinhauser
16.5 cm,

Oral Instruments



Steinhilber
SLD-14-167-05
Orbital Osteotome
18 cm,



Wolford
SLD-14-168-06
Osteotome
23 cm,



Salyer
SLD-15-101-18
Cleft Palate Hooklet
18.5 cm,



Salyer
SLD-15-102-18
Cleft Palate Hooklet
18.5 cm,



Salyer
SLD-15-103-08
Cleft Palate Dissector
18.5 cm,



Salyer
SLD-15-104-18
Cleft Palate Dissector
18 cm,



Salyer
SLD-15-105-18
Cleft Palate Elevator
18 cm,



Salyer
SLD-15-106-18
Cleft Palate Elevator
18 cm,



Salyer
SLD-15-107-18
Cleft Palate Elevator
18 cm,



JABOMA
SLD-15-108-17
Cleft Palate Periosteal Elevator
17 cm,



Hurd
SLD-15-109-21
Cleft Palate Needle
20.5 cm,



Hurd
SLD-15-111-21
Cleft Palate Needle
20.5 cm,

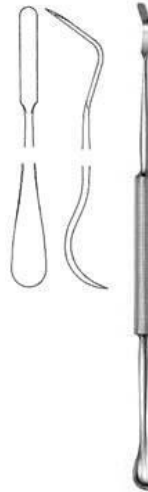

Carpenter
SLD-15-112-25
Tonsil Knife / Enucleator
25 cm,



Hurd
SLD-15-113-22
Tonsil Dissector/Retractor
22.5 cm,

Tonsil



Henke
SLD-15-114-23
Tonsil Elevator
22.5 cm,



Henke
SLD-15-115-23
Tonsil Elevator
22.5 cm,

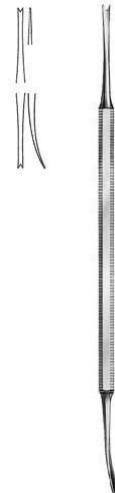

Luniatschek
SLD-15-116-19
Gauze Packer
17.5 cm,



Luniatschek
SLD-15-117-17
Gauze Packer
17.5 cm,

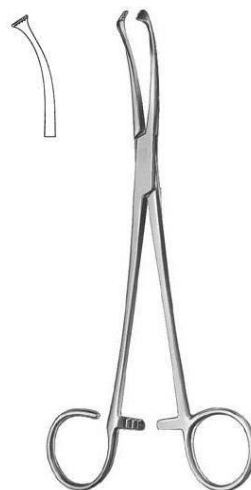

White
SLD-15-118-18
Tonsil Grasping Forceps
18 cm,



Blohmke
SLD-15-119-20
Tonsil Grasping Forceps
20 cm,

Tonsil

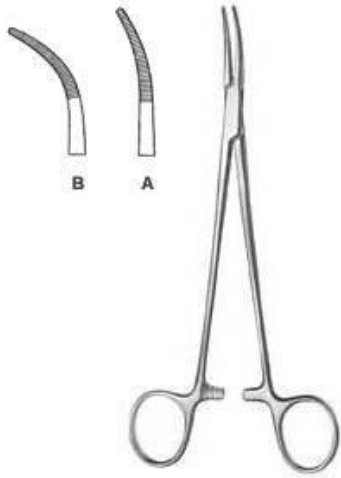

Schnidt
SLD-15-120-19
 Tonsil Forceps
 19 cm,

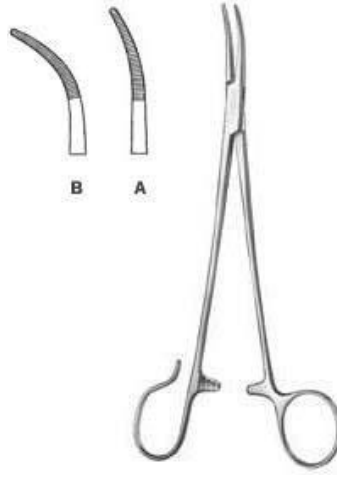

Schnidt
SLD-15-121-19
 Tonsil Forceps
 19 cm, 18.5 cm,



Eves
SLD-15-122-28
 Tonsil Snare
 28.5 cm,



Eves
SLD-15-123-28
 Tonsil Snare
 28.5 cm,

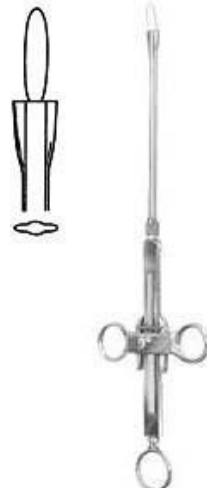

Brunings
SLD-15-124-28
 Tonsil Snare
 29 cm,

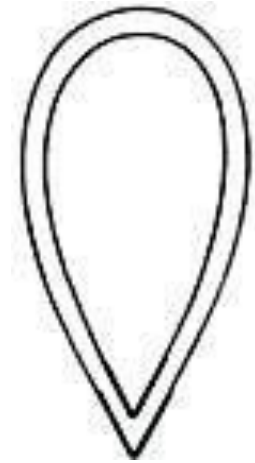

Wire Loop
SLD-15-125-40

Tonsil



Snare Wire
SLD-15-126-01

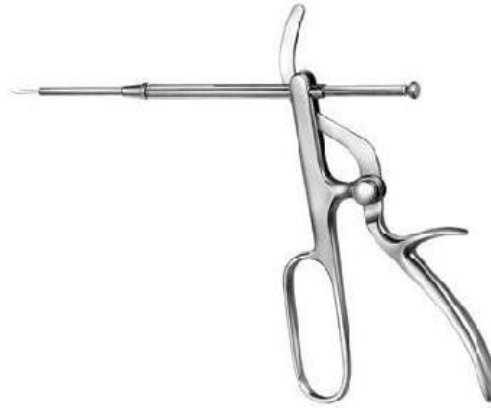

Tyding
SLD-15-127-01
Tonsil Snare



Hartmann
SLD-15-128-13
Tonsil Punch
12 cm,



Huber
SLD-15-129-01
Universal Handle
20 cm,30 cm,40 cm,



Bruenings
SLD-15-130-20
Interchangeable Tube



Bruenings
SLD-15-131-20
Laryngeal Tube
cm,

20

Tracheotomy

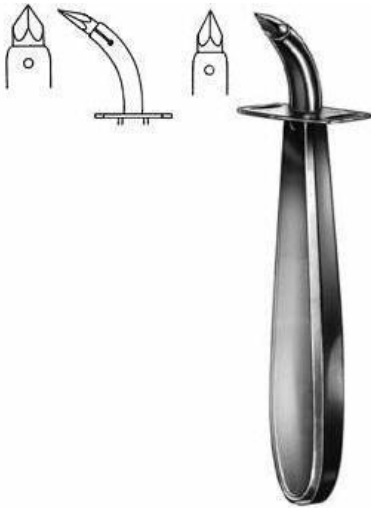

Ueckermann
SLD-16-101-13
Tracheotomy Trocar
11.5 cm,



Iterson
SLD-16-102-16
Tracheal Hook
17 cm,



Rose
SLD-16-103-13
Tracheal Hook
13.5 cm,



Luer
SLD-16-104-11
Tracheal Hook
11 cm,

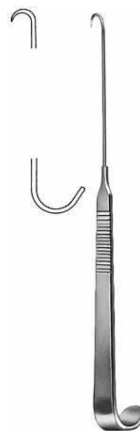

SLD-16-105-15
Tracheal Hook
15 cm,



Lukens
SLD-16-106-17
Thymus Retractor
17.5 cm,

Tracheotomy



Jackson
SLD-16-107-17
Tracheal Hook
18 cm,



Kocher
SLD-16-108-15
Goitre Enucleator
16.5 cm,



Kocher
SLD-16-109-15
Goitre Enucleator
16.5 cm,



Hofmeister
SLD-16-110-21
Goitre Enucleator
20.5 cm,

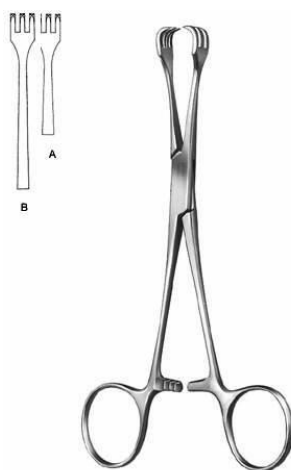

Lahey
SLD-16-111-15
Goitre Grasping Forceps
15.5 cm,



Luer
SLD-16-112-04
Tracheal Tube

Tracheotomy



Luer
SLD-16-113-08
Tracheal Tube



Chevalier-Jackson
SLD-16-114-04
Tracheal Tube outer tube closed inner tube
closed silver



SLD-16-115-08
Speaking Tube

Dermatology



Moncorps
SLD-17-101-14
 Milium Knife
 14 cm,



Moncorps
SLD-17-102-00
 Spare Blade



Vidal
SLD-17-103-14
 Lupus Scraper
 cm,

13



Wolff
SLD-17-105-01
 Lupus Curette
 14 cm,



Kilner
SLD-17-106-15
 Skin Hooklet
 14.5 cm,



Gillies
SLD-17-107-18
 Skin Hooklet
 18 cm,

Dermatology



Kaye
SLD-17-108-03
 Face-lift Hook
 13 cm,

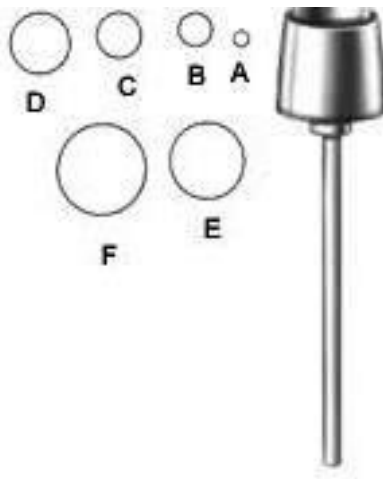

SLD-17-109-02
 Dermal Punch
 5.5 cm,



Handle
SLD-17-110-00
 8 cm,

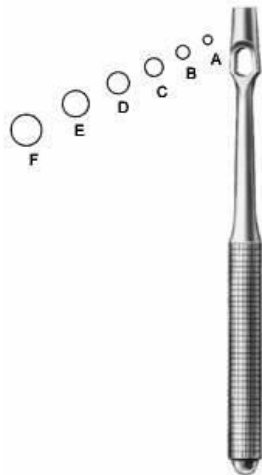

Keyes
SLD-17-111-02
 Dermal Punch
 11 cm,



Unna
SLD-17-113-14
 Comedone Extractor
 14.5 cm,



Saalfeld
SLD-17-114-10
 Comedone Extractor
 11 cm,



Saalfeld
SLD-17-115-14
 Saalfeld Comedone Extractor
 14.5 cm,



Schamberg
SLD-17-116-10
 Comedone Extractor
 9.5 cm,



Katsch
SLD-17-117-14
 Comedone Extractor
 16 cm,



Unna-Vidal
SLD-17-118-11
 Comedone Extractor
 11.5 cm,



d'Assump?
SLD-17-119-15
 Face-lift Forceps
 18 cm,



Gregory
SLD-17-120-14
 Face-lift Scissors
 14 cm,

Dermatology

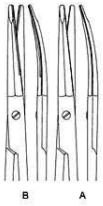

Kaye
SLD-17-121-15
 Face-lift Scissors
 15 cm, 18 cm,



Stella-S
SLD-17-122-18
 Face-lift Scissors
 18 cm,



Gorney
SLD-17-123-18
 Face-lift Scissors
 18 cm,

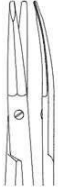

Freeman-Kaye
SLD-17-124-18
 Face-lift Scissors
 18 cm,



Freeman
SLD-17-125-00
 Face-lift Scissors
 23 cm,



Fox
SLD-17-104-01
 Lupus Curette
 14 cm,



Unna
SLD-17-112-14
Comedone Extractor
14.5 cm,

Intestines & Stomach



Allis-Baby

SLD-18-101-12

Intestinal and Tissue Grasping Forceps
13 cm,

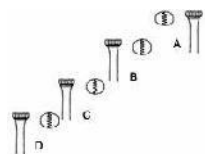

Allis

SLD-18-102-15

Intestinal and Tissue Grasping Forceps
15.5 cm, 19 cm, 25.5 cm,

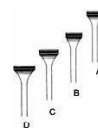

Allis

SLD-18-103-16

Intestinal and Tissue Grasping Forceps
15.5 cm, 20 cm, 24.5 cm, 30 cm,



Allis-Adair

SLD-18-104-15

Intestinal and Tissue Grasping Forceps
16 cm,



Boys-Allis

SLD-18-105-15

Intestinal and Tissue Grasping Forceps
15.5 cm,



Thoms-Allis

SLD-18-106-20

Intestinal and Tissue Grasping Forceps
20.5 cm,

Intestines & Stomach



Allis

SLD-18-107-20

Intestinal and Tissue Grasping Forceps
20 cm,

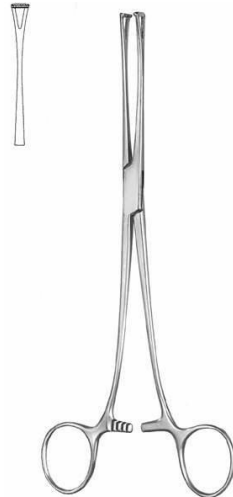

Lockwood

SLD-18-108-20

Intestinal and Tissue Grasping Forceps
20 cm,



Williams

SLD-18-109-16

Intestinal and Tissue Grasping Forceps
16.5 cm,

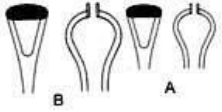

Babcock

SLD-18-110-16

Intestinal and Tissue Grasping Forceps
16.5 cm, 21 cm,

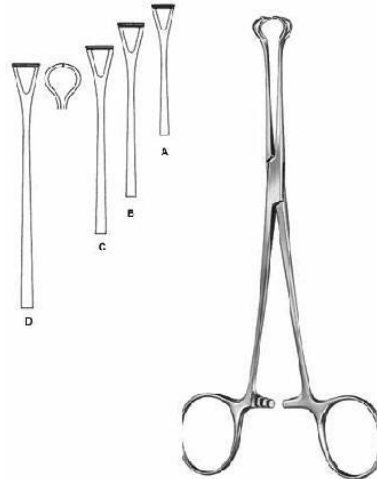

Babcock

SLD-18-111-16

Intestinal and Tissue Grasping Forceps
15.5 cm, 17.5 cm, 21 cm, 24 cm,

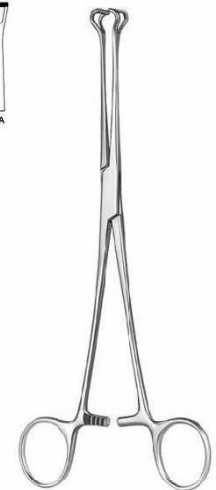

Babcock

SLD-18-112-16

Intestinal and Tissue Grasping Forceps
16 cm, 20.5 cm,

Intestines & Stomach



Duval

SLD-18-113-20

Intestinal and Tissue Grasping Forceps
20.5 cm,

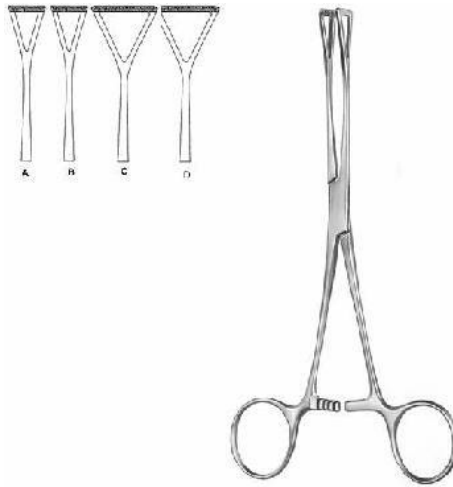

Duval

SLD-18-114-18

Intestinal and Tissue Grasping Forceps
18 cm, 20.5 cm, 23 cm,

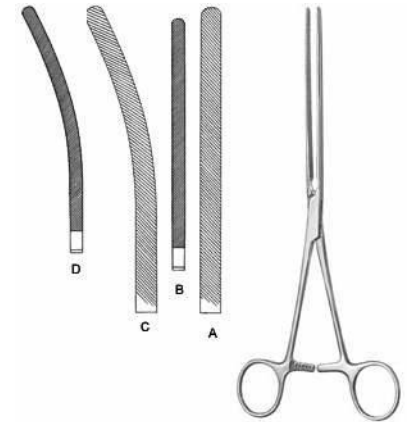

Doyen

SLD-18-115-21

Intestinal Clamp
21.5 cm, 23.5 cm,

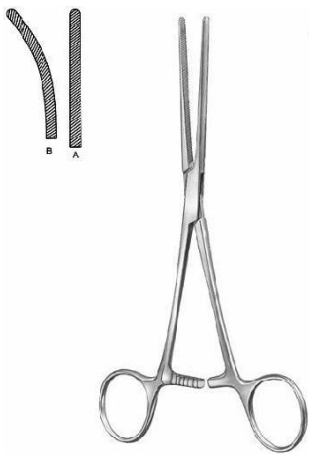

Doyen-Baby

SLD-18-116-18

Intestinal Clamp
18 cm, 17.5 cm,

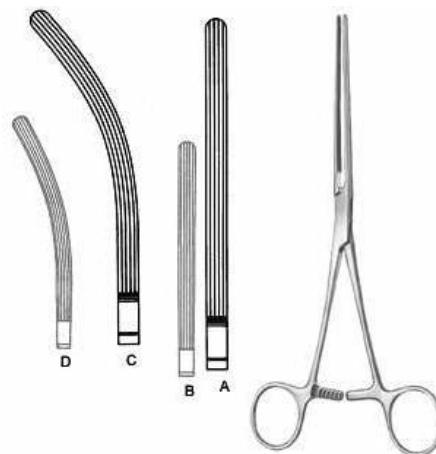

Mayo-Robson

SLD-18-117-21

Intestinal Clamp
21.5 cm, 23.5 cm, 23 cm,

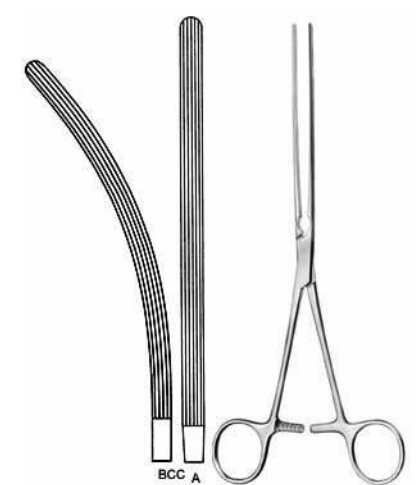

Mayo-Robson

SLD-18-118-25

Intestinal Clamp
25.5 cm, 24.5 cm,

Intestines & Stomach

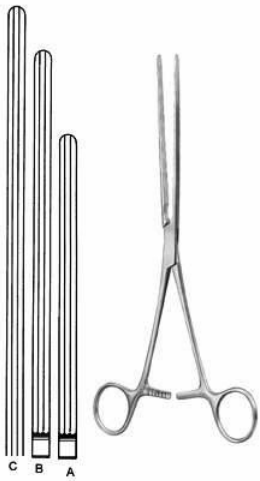

Kocher

SLD-18-119-22

Intestinal Clamp
22.5 cm, 25 cm, 28.5 cm,

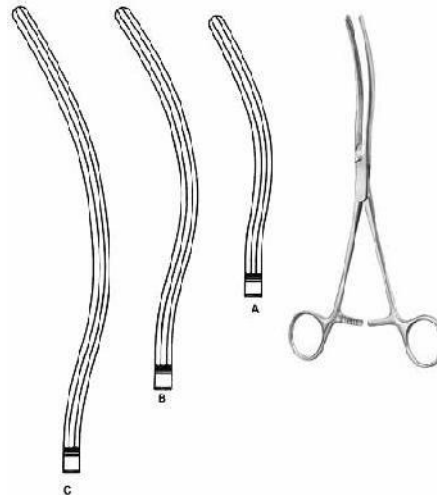

Kocher

SLD-18-120-22

Intestinal Clamp
22 cm, 24.5 cm, 27.5 cm,



Allen

SLD-18-121-16

Intestinal Clamp
16 cm,



Payr-Baby

SLD-18-122-15

Intestinal and Pylorus Clamp
15 cm,

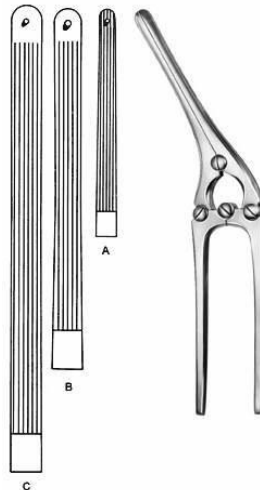

Payr

SLD-18-123-21

Intestinal and Pylorus Clamp
20.5 cm, 29 cm, 34.5 cm,



Stone-Watt

SLD-18-124-07

Intestinal Anastomosis Clamp
8.5 cm, 10 cm,

Intestines & Stomach



Stone-Watt
SLD-18-125-15
 Closing Forceps

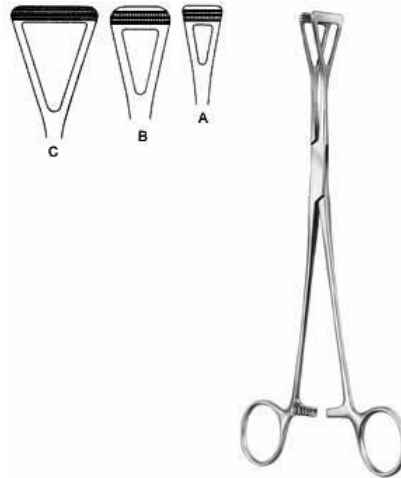

Scheibe
SLD-18-126-18
 Organ Grasping Forceps
 18 cm,

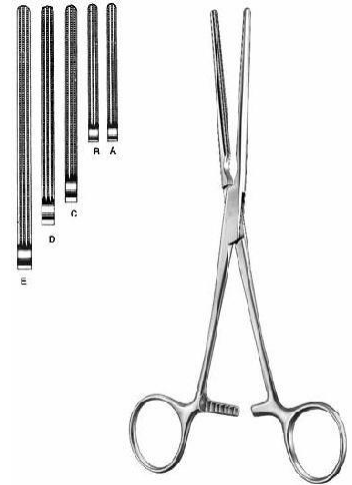

Doyen-Baby
SLD-18-127-13
 Intestinal Clamp
 14 cm, 17 cm,

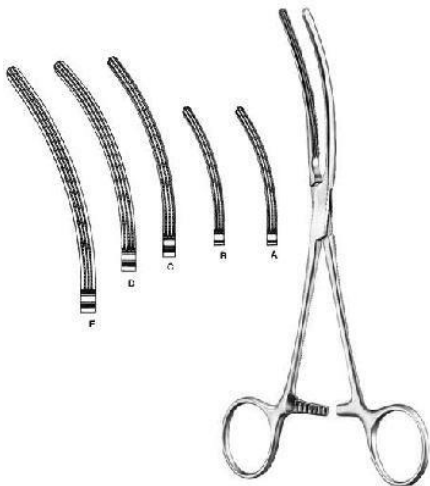

Doyen-Baby
SLD-18-128-13
 Intestinal Clamp
 13.5 cm, 17 cm,



Mayo-Robson
SLD-18-129-25
 Intestinal Clamp
 26 cm,



Mayo-Robson
SLD-18-130-25
 Intestinal Clamp
 25 cm,

Intestines & Stomach

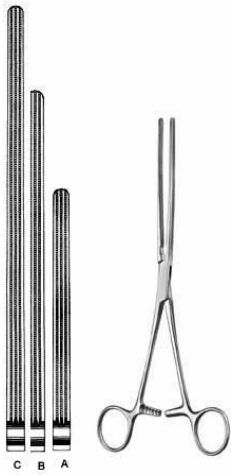

Kocher

SLD-18-131-22

Intestinal Clamp
22.5 cm, 28 cm,

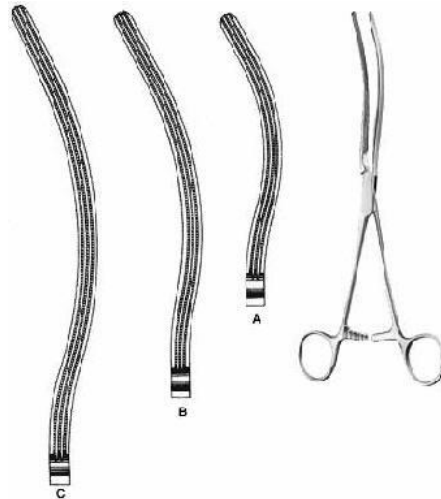

Kocher

SLD-18-132-22

Intestinal Clamp
22 cm, 25 cm, 27.5 cm,

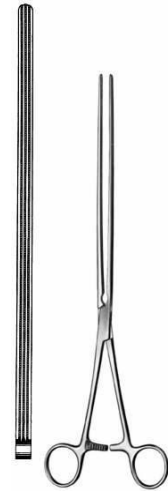

Scudder

SLD-18-133-33

Intestinal Clamp
33.5 cm,

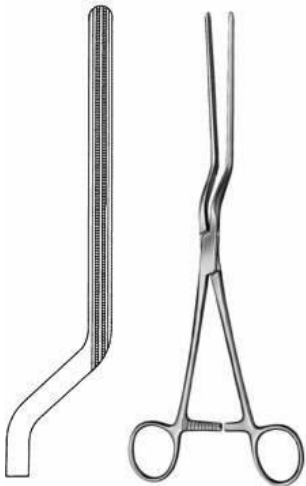

Brunner

SLD-18-134-24

Sigmoid Anastomosis Forceps
27 cm,

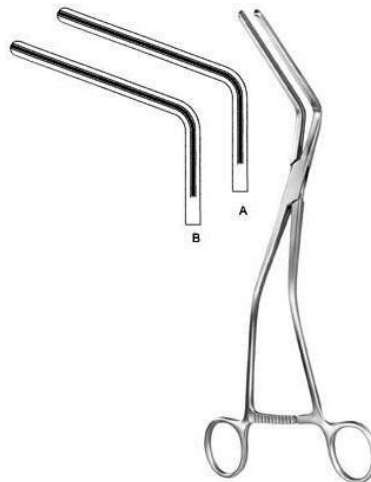

Hayes

SLD-18-135-26

Sigmoid Anastomosis Forceps
27 cm, 28 cm,



Veidenheimer

SLD-18-136-23

Sigmoid Anastomosis Forceps
25 cm,

Intestines & Stomach



Fehland
SLD-18-137-24
Sigmoid Anastomosis Forceps
24 cm,

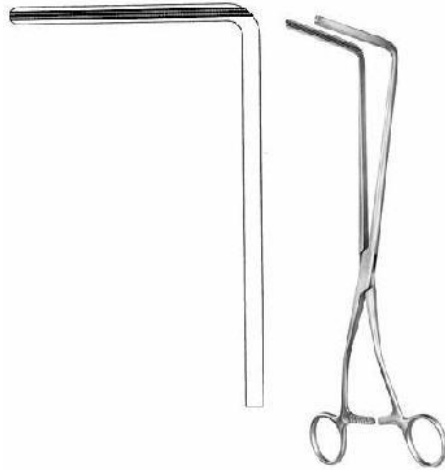

Resano
SLD-18-138-30
Sigmoid Anastomosis Forceps
28 cm,



Sims
SLD-18-139-15
Rectal Speculum
15.5 cm,



Sims
SLD-18-140-15
Rectal Speculum
15.5 cm,



Mathieu
SLD-18-141-19
Rectal Speculum
19 cm,



Alan-Parks
SLD-18-142-00
Alan-Parks
14 cm,

Intestines & Stomach

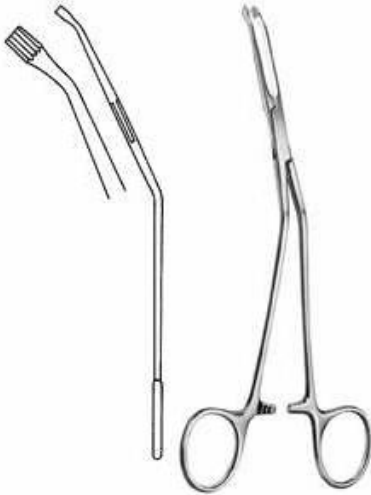

McGinvey

SLD-18-143-19

Hemorrhoidal Grasping Forceps
19 cm,



SLD-18-144-00

Handle for biopsy forceps

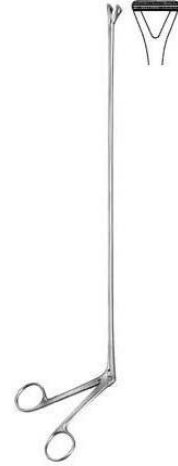

SLD-18-145-38

Rectal Biopsy Forceps

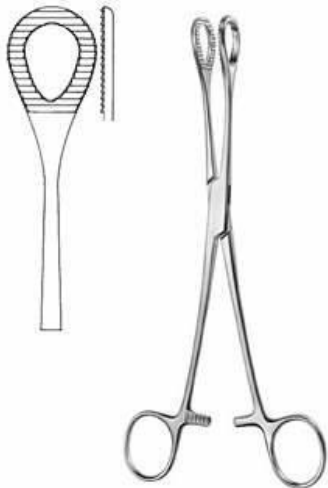

Heywood-Smith

SLD-18-146-21

Polypus Grasping Forceps
21 cm,

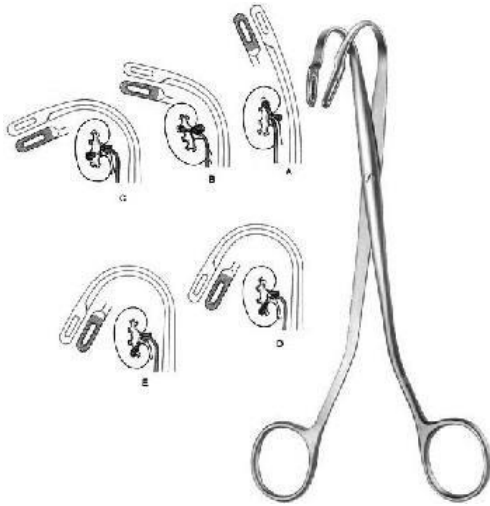

Randall

SLD-19-101-23 A

Kidney Stone Forceps

23 cm Fig. 1, 21 cm Fig. 2, 19 cm Fig. 3,

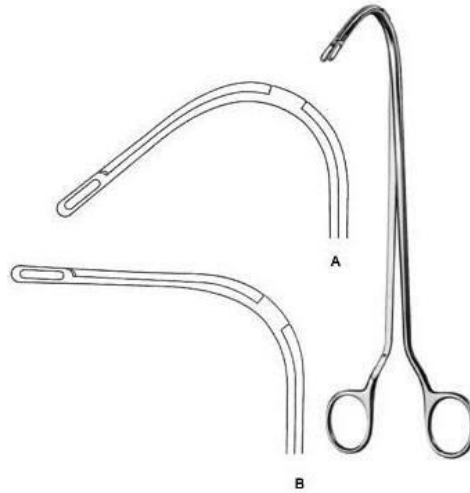

Randall

SLD-19-102-23 A

Kidney Stone Forceps

23 cm, 24.5 cm,

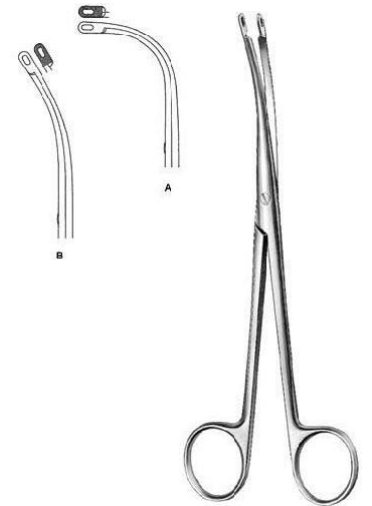

Heiming

SLD-19-103-16 A

Kidney Stone Forceps

16 cm Fig. 1, 17 cm Fig. 2,

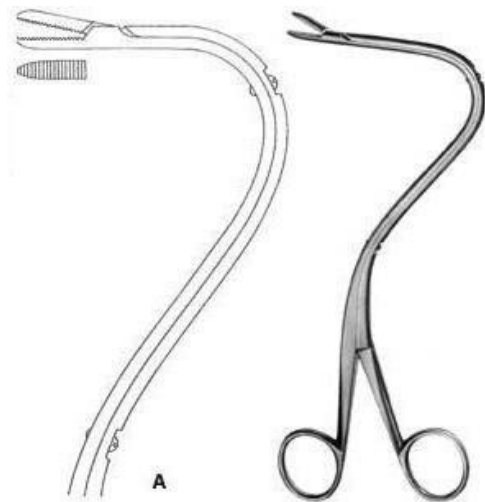

Elsasser

SLD-19-104-01 A

Nephrostomy Forceps

21 cm Fig. 1, 21 cm Fig. 2,



Bakes

SLD-19-105-01 A

Gall Duct Dilator

32 cm,

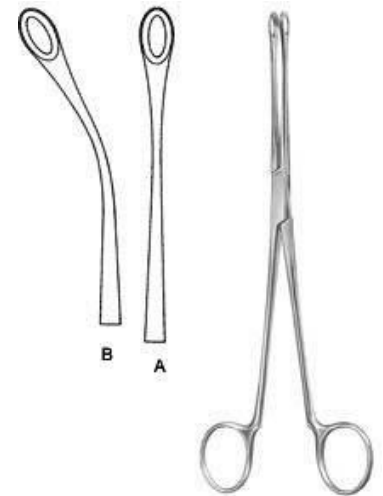

Blake

SLD-19-106-20 A

Gall Stone Forceps

21 cm,



Mayo-Blake
SLD-19-107-20
 Gall Stone Forceps
 21 cm,



Mayo-Blake
SLD-19-108-20
 Gall Stone Forceps
 21 cm,



Mixer
SLD-19-109-22
 Gall Stone Forceps
 21.5 cm,



Desjardins
SLD-19-110-23 A
 Gall Stone Forceps
 23 cm,

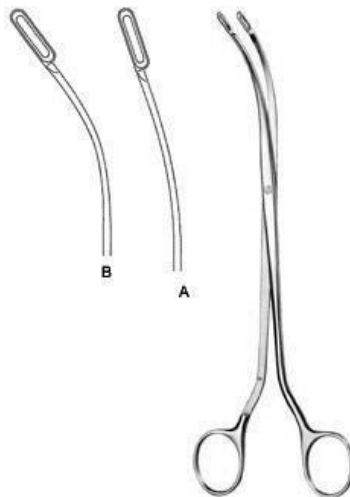

Desjardins
SLD-19-111-24 A
 Gall Stone Forceps



Luer-Korte
SLD-19-112-01 A
 Gall Stone Scoop
 32 cm Fig. 0, 32 cm Fig. 00, 32 cm Fig. 000, 32 cm Fig. 1, 32 cm Fig. 2, 32 cm Fig. 3, 32 cm Fig. 4,

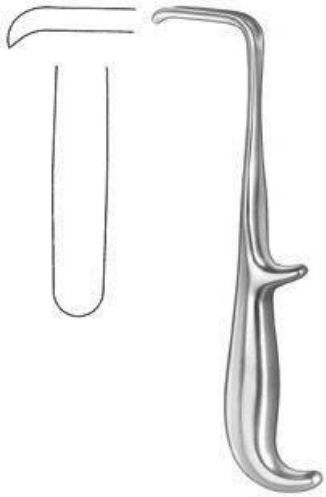

Young
SLD-19-113-21
Prostatic Retractor
21.5 cm,



Young
SLD-19-114-22
Prostatic Retractor
20.5 cm,



Young
SLD-19-115-21
Prostatic Retractor
22 cm,

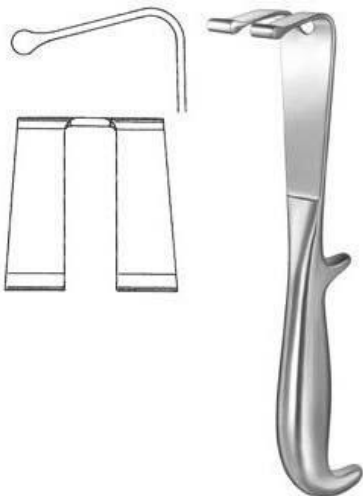

Young
SLD-19-116-22
Prostatic Retractor
21.5 cm,



Millin
SLD-19-117-24
Capsule Forceps
24.5 cm,

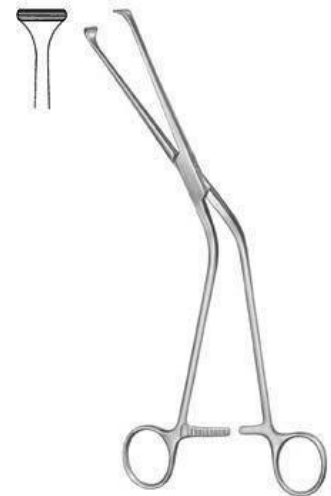

Millin
SLD-19-118-24
Capsule Forceps
22 cm,

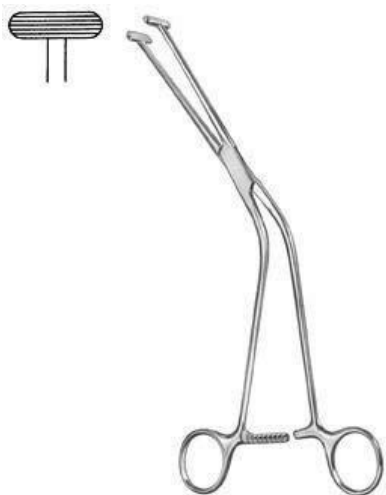

Millin
SLD-19-119-23
 Capsule Forceps
 24.5 cm,

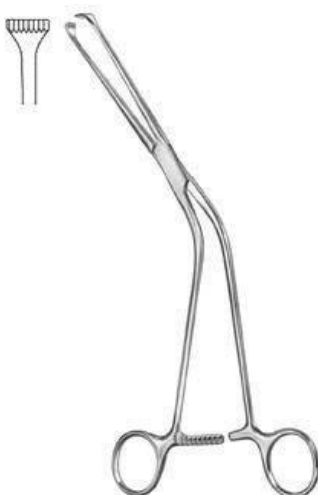

Millin
SLD-19-120-23
 Capsule Forceps
 22 cm,

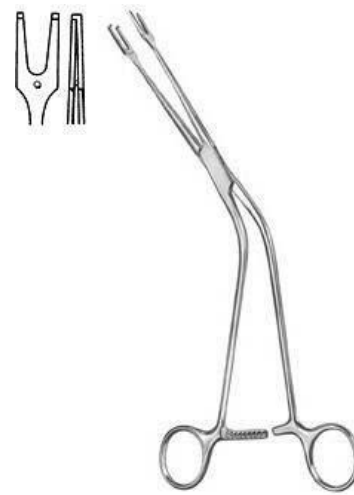

Millin
SLD-19-121-24
 Ligature Carrying Forceps
 24.5 cm,



Millin
SLD-19-122-00
 Bladder Neck Spreader
 29,



Thomson-Walker
SLD-19-123-00
 Bladder Retractor



Judd-Masson
SLD-19-124-00
 Bladder Retractor

Urology



Millin

SLD-19-125-00 A
Bladder Retractor



Legueu

SLD-19-126-27
Bladder Spatula
24 cm 35 mm,

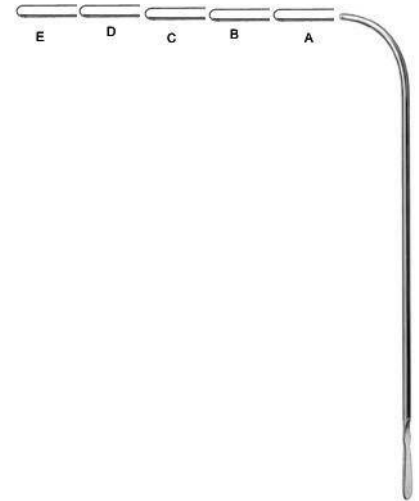

Van Buren

SLD-19-127-00 A
Urethral Sound
27.5 cm,

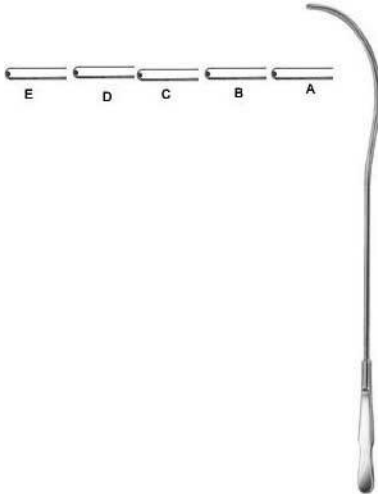

Guyon

SLD-19-128-10 A
Urethral Sound
26 cm,



Cusco
SLD-20-101
Vaginal Speculum
75 x 32 mm, 85 x 35 mm,



Cusco
SLD-20-102-01
Vaginal Speculum
75 x 18 mm,



Cusco
SLD-20-103-01
Vaginal Speculum
80 x 22 mm, 100 x 25 mm, 105 x 27 mm,



Cusco
SLD-20-104-01
Vaginal Speculum
75 x 34 mm, 85 x 37 mm,



Collin
SLD-20-105-01
Vaginal Speculum
85 x 30 mm, 100 x 35 mm,



Pederson
SLD-20-106-01
Vaginal Speculum
75 x 13 mm, 100 x 22 mm,



Grave

SLD-20-107-01

Vaginal Speculum
75 x 20 mm, 95 x 35 mm,

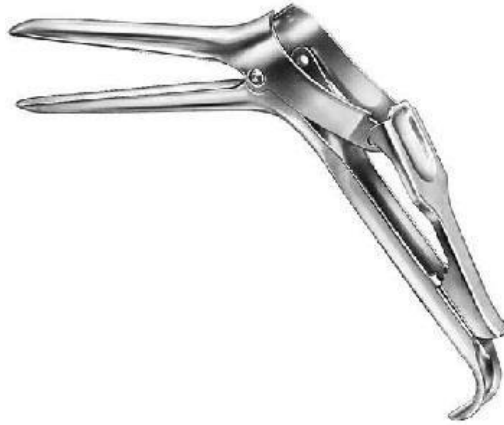

Semm

SLD-20-108-01

Vaginal Speculum
100 x 20 mm, 105 x 27 mm,



Sims

SLD-20-109-01

Vaginal Speculum
65 x 25 mm, 70 x 30 mm,



Kristeller

SLD-20-110-01

Vaginal Speculum
70 x 27 mm,



Kristeller

SLD-20-111-01

Vaginal Retractor
75 x 23 mm,



Kristeller

SLD-20-112-01

Vaginal Speculum
Size 1,



Kristeller
SLD-20-113-01
Vaginal Speculum
105 x 18 mm,



Kristeller
SLD-20-114-01
Vaginal Retractor
110 x 14 mm,



Kristeller
SLD-20-115-01
Vaginal Speculum
Size 1,

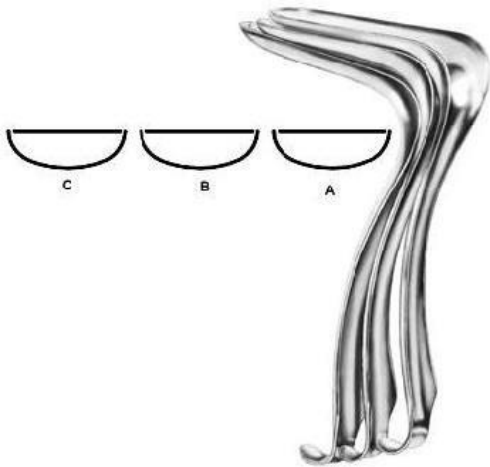

Kristeller
SLD-20-116-01
Vaginal Speculum
105 x 26 mm,

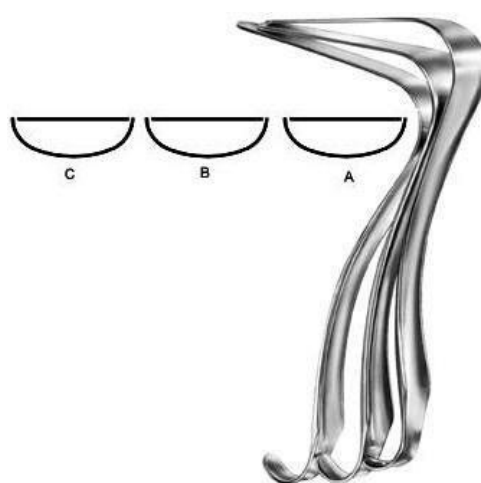

Kristeller
SLD-20-117-01
Vaginal Retractor
115 x 22 mm, 115 x 24 mm,



Kristeller
SLD-20-118-01
Vaginal Speculum
Size 1,

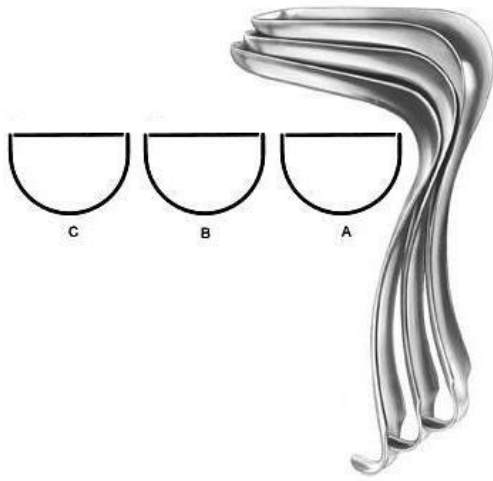

Kristeller
SLD-20-119-01
 Vaginal Speculum
 110 x 27 mm,

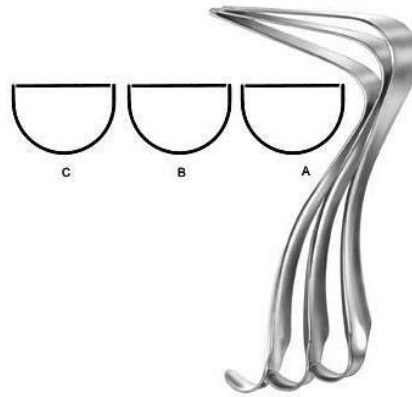

Kristeller
SLD-20-120-01
 Vaginal Retractor
 115 x 23 mm,



Kallmorgen
SLD-20-121-01
 Vaginal Speculum



Kallmorgen
SLD-20-122-01
 Vaginal Retractor
 70 x 40 mm Fig. 1, 90 x 40 mm Fig. 2,



Kallmorgen
SLD-20-123-01
 Vaginal Speculum
 70 x 33 mm, 90 x 33 mm,

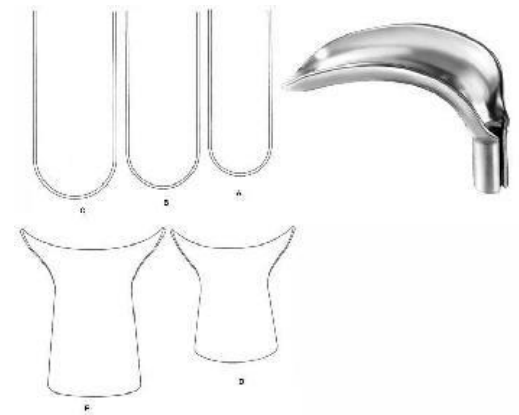

Scherbak
SLD-20-125-00
 Vaginal Speculum
 Size 1,

Gynecology



Auvard
SLD-20-126-22
 Vaginal Speculum
 80 x 43 mm,



Weissbarth
SLD-20-127-24
 Vaginal Speculum
 21 cm 80 x 42 mm,



Breisky
SLD-20-128-20
 Vaginal Speculum
 29 cm 100 x 20 mm, 29 cm 100 x 25 mm,



Kogan
SLD-20-129-24
 Endocervical Speculum
 25 cm 70 x 30 mm,



Kogan
SLD-20-130-24
 Endocervical Speculum
 24.5 cm,



Hegar
SLD-20-131-24
 Uterine Dilator
 18.5 cm 1,0,



Hegar

SLD-20-132-02
Uterine Dilator
20 cm 1,0,



Hank

SLD-20-133-10
Uterine Dilator
26.5 cm Fig. 9/10,



Sims

SLD-20-134-32
Uterine Sound
33 cm,



Valleix

SLD-20-135-25
Uterine Sound
29.5 cm,



Braun

SLD-20-136-26
Uterine Depressor
27.5 cm,



Schroder

SLD-20-137-25
Uterine Tenaculum Forceps
25.5 cm,



Braun
SLD-20-138-25
Uterine Tenaculum Forceps
26 cm,



Duplay
SLD-20-139-28
Uterine Tenaculum Forceps
25.5 cm,



Beacham
SLD-20-140-26
Amniotome
26 cm,



Skene
SLD-20-141-24
Uterine Tenaculum Forceps
24 cm,

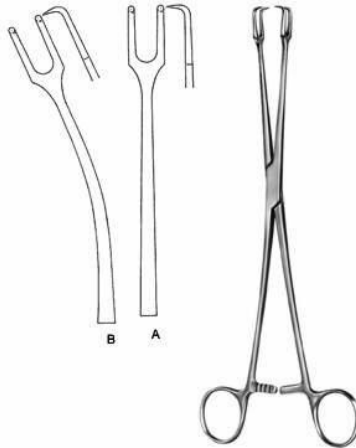

Schroder
IN-20-142-24
Uterine Tenaculum Forceps
25 cm,



Teale
SLD-20-143-23
Uterine Tenaculum Forceps
23.5 cm,



Iowa

SLD-20-144-26

Uterine Tenaculum Forceps
26 cm,

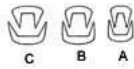

Museux

SLD-20-145-24

Uterine Tenaculum Forceps
24 cm,



Jacobs

SLD-20-146-21

Uterine Tenaculum Forceps
21 cm,

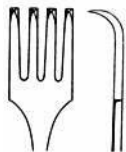

SLD-20-147-26

Uterine Tenaculum Forceps
26.5 cm,



Braun

SLD-20-148-16

Uterine Tenaculum Forceps
16 cm,

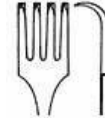

Czerny

SLD-20-149-21

Uterine Tenaculum Forceps
21 cm,



Kelly
SLD-20-150-32
Uterine Polypus Forceps
32 cm,



Noto
SLD-20-151-27
Uterine Polypus Forceps
27 cm,

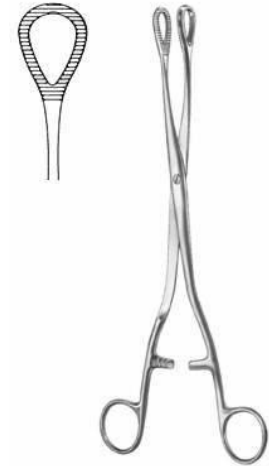

Heywood-Smith
SLD-20-152-25
Uterine Polypus Forceps
25 cm,



Doyen
SLD-20-153-17
Myoma Screw
17 cm,



Doyen
SLD-20-154-17
Myoma Screw
14.5 cm,



Segond
SLD-20-155-27
Myoma Knife
28 cm,

Gynecology

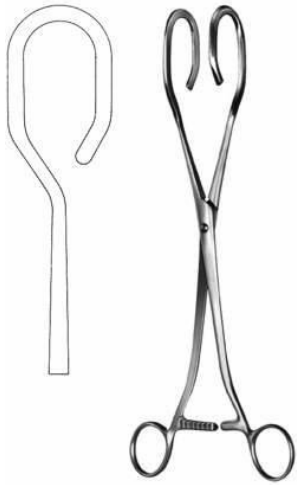

Dartigues

SLD-20-156-27

Uterine Seizing Forceps
28 cm,

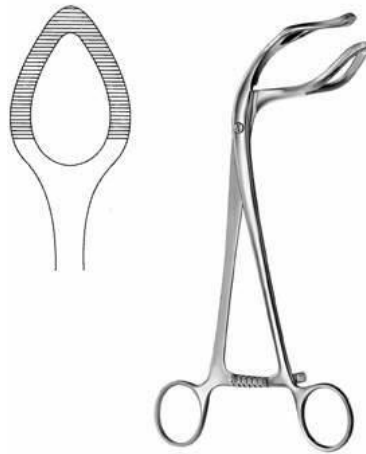

Somer

SLD-20-157-27

Uterine Seizing Forceps
22.5 cm,



Collin

SLD-20-158-25

Uterine Seizing Forceps jaw 40 mm wide
26 cm,



Ayre

SLD-20-159-23

Conization Knife cutting edge 3,6 mm wide
23.5 cm,



Emmett

SLD-20-160-03

Fistula Hook
22 cm Fig.3,



Simon

SLD-20-161-22

Fistula Hook
21.5 cm,



Simon
SLD-20-162-22
Fistula Hook
21.5 cm,



Novak
SLD-20-163-23
Suction Curette 4 mm ?
24.5 cm,



Kevorkian
SLD-20-164-23
Uterine Biopsy Curette 6,0 mm ?
30 cm,



Munchen
SLD-20-165-27
Uterine Biopsy Curette 4,8 mm ?
27 cm,



Gellhorn
SLD-20-166-23
Uterine Biopsy Forceps jaw 8,6 mm wide
24 cm,



Faure
SLD-20-167-21
Faure Uterine Biopsy Forceps
21 cm,

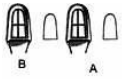

Schubert
SLD-20-168-21

Uterine Biopsy Forceps jaw 4,8 mm wide
21.5 cm, 28 cm,

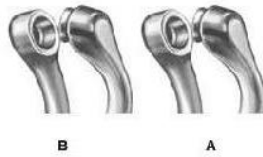

Thoms-Gaylor
SLD-20-169-22

Uterine Biopsy Forceps jaw 5,6 mm ?
21 cm, 23.5 cm,

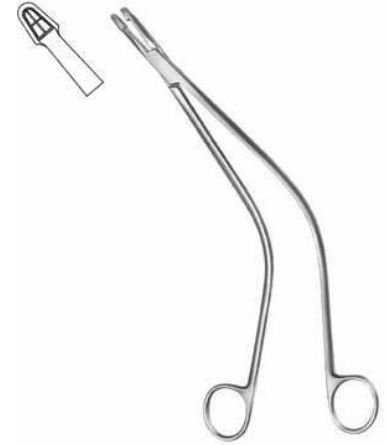

Schubert
SLD-20-170-26

Schubert Uterine Biopsy Forceps
25.5 cm,

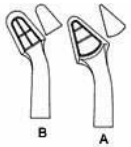

Van Doren
SLD-20-171-24

Uterine Biopsy Forceps jaw 4,9 mm wide
27 cm, 25.5 cm,



Alexander
SLD-20-172-28

Uterine Biopsy Forceps jaw 5,1 mm wide
28 cm,



Kevorkian
SLD-20-173-32

Uterine Biopsy Forceps
25 cm,

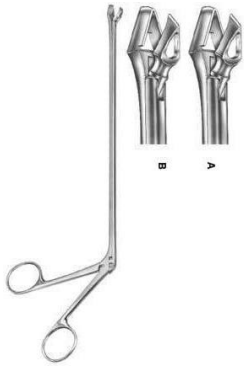

Schumacher
SLD-20-174-01

Uterine Biopsy Forceps jaw 4,6 / 5,4 mm wide
24 cm,



Schumacher
SLD-20-175-00

Uterine Biopsy Forceps
25 cm,



SLD-20-176-22

IUP Grasping Forceps 3 mm ?
22 cm,

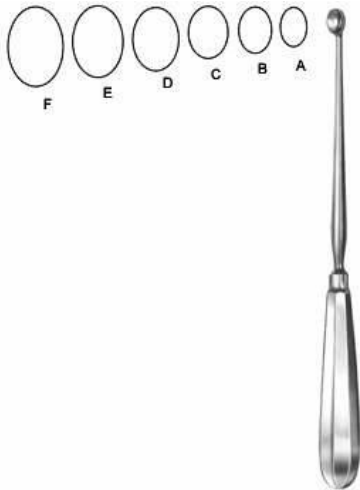

Simon

SLD-20-177-01

Uterine Scoop

24.5 cm 9,8 x 8,6 mm, 24.5 cm 11,6 x 8,3 mm,

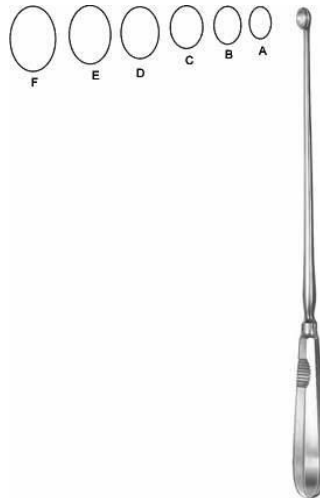

Simon

SLD-20-178-01

Uterine Scoop

30 cm 9,8 x 8,6 mm, 30 cm 11,6 x 8,3 mm,



Recamier

SLD-20-179-05

Uterine Curette

31 cm Fig. 00 5 mm, 31 cm Fig. 0 6 mm,

Gynecology



Recamier

SLD-20-180-05

Uterine Curette

31 cm Fig. 00 5 mm, 31 cm Fig. 0 6 mm,



Sims

SLD-20-181-05

Uterine Curette

31 cm Fig. 00 5 mm, 31 cm Fig. 0 6 mm,



Sims

SLD-20-182-05

Uterine Curette

31 cm Fig. 00 5 mm, 31 cm Fig. 0 6 mm,

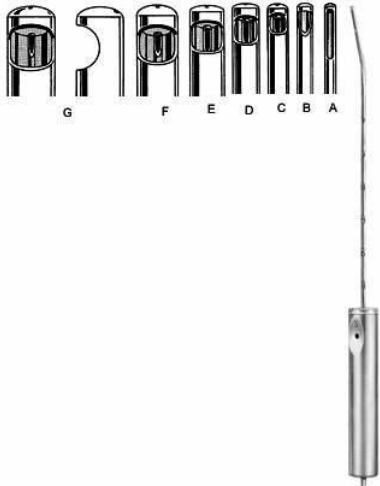

SLD-20-183-03

Suction Curette

29 cm 3,0 mm ?, 29 cm 4,5 mm ?, 29 cm 6,0 mm ?,



Martin

SLD-21-101-34

Pelvimeter cm, inch scale
34 cm,



Nagele

SLD-05-102-36

Obstetrical Forceps
35 cm, 40.5 cm,



Simpson

SLD-05-103-30

Obstetrical Forceps
31 cm,



Wrigley

SLD-05-104-28

Obstetrical Forceps
28 cm,



Simpson

SLD-21-105-36

Obstetrical Forceps
36.5 cm,



Kielland

SLD-21-106-41

Obstetrical Forceps
42 cm,

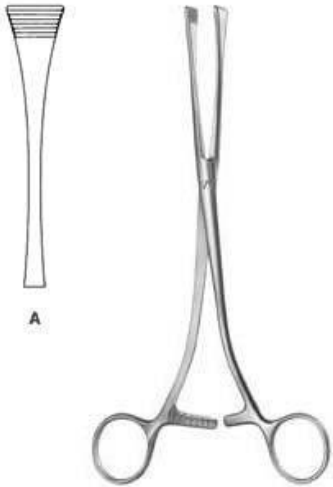

Green-Armytage
SLD-21-107-21
 Uterine Clamp
 21 cm,



Sellheim
SLD-21-108-28
 Obstetrical Lever
 32 cm,

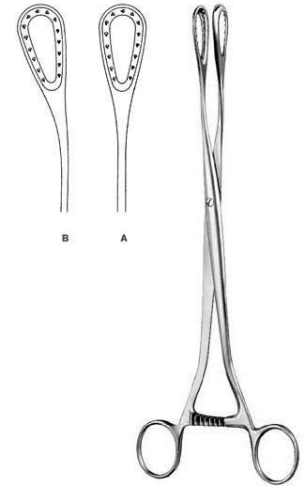

Sanger
SLD-21-109-27
 Placenta and Ovum Forceps
 27.5 cm, 27 cm,

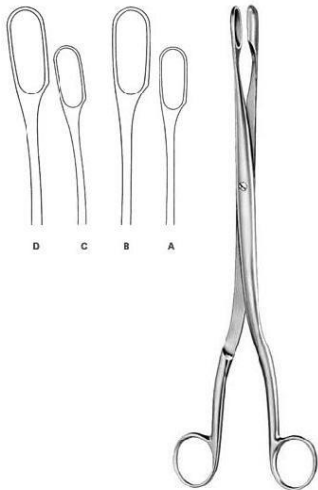

Winter
SLD-21-110-01
 Placenta and Ovum Forceps
 28 cm Fig. 1, 28 cm Fig. 2,

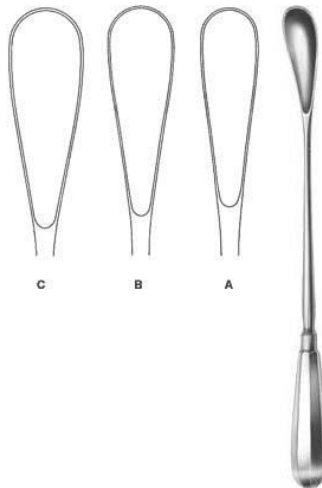

Cuzzi
SLD-21-111-01
 Placenta Scoop
 30 cm 14,5 mm, 30 cm 18 mm,



Pestaloza
SLD-21-112-30
 Placenta Scoop
 30 cm,

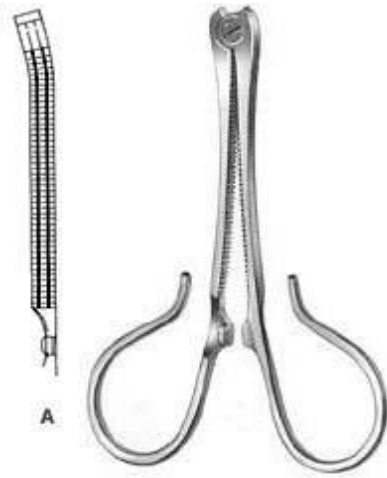

Kane
SLD-21-113-08
Umbilical Cord Clamp
8.5 cm,



Collin
SLD-21-114-09
Umbilical Cord Clamp
8.5 cm,

Sterilization



Irrigator
SLD-23-101-10
Size 1,



Round Bowl
SLD-23-102-16
220 mm x 70 mm, 400 mm x 150 mm,



SLD-23-103-33
Round Bowl
? x h 6,00 l,



Flat Dish
SLD-23-104-11
? x h 0,20 l,



Lid only
SLD-23-105-11
Size 1,



Stainless Steel
SLD-23-106-04
? x h 0,30 l,

Sterilization



Round Dish

SLD-23-107-11

? x h 0,30 l, ? 128 x 38 mm 0,40 l,



Flat Dish

SLD-23-108-11

? x h 0,15 l,



Measurer

SLD-23-109-01

graduated inside
100cc = 0,1 l,



Measurer

SLD-23-110-02

Graduated Inside
0,25 l, 0,50 l,



Petri Dish

SLD-23-111-10

with Lid ? x h



Petri Dish

SLD-23-112-09

without lid ? x h
Size 1,

Sterilization



Lid for Petri Dishes
SLD-23-113-10
Size 1,



Universal Tray
SLD-23-114-23
l x b x h,



Instrument Tray
SLD-23-115-21
l x b x h,



Universal Tray
SLD-23-116-23
l x b x h,



Round Bowl
SLD-23-117-22
? x h,



Metal Jar
SLD-23-118-30
? 30mm x 90 mm, ? 50mm x 100 mm,

Sterilization



Instrument Box
SLD-23-119-16
lid with knob
l x b x h,



Instrument Box
SLD-23-120-16
lid with knob
l x b x h,



Instrument Box
SLD-23-121-20
l x b x h,



Round Metal Box
SLD-23-122-06
? 75 mm x 75 mm, ? 100 mm x 60 mm,



Medicine Cup Graduated Inside
SLD-23-123-25
25 ccm,



Medicine Cup Graduated Inside
SLD-23-124-50
50 ccm,

Sterilization



Tablet Tray
SLD-23-125-75
? 75 mm x 12 mm,



Metal Cup
SLD-23-126-90
? 90 mm x 90 mm,



Denture Cup
SLD-23-127-75
? 75 mm x 50 mm,



Insert for Cup
SLD-23-128-75
? 73 mm x 75 mm,



Kidney Dish
SLD-23-129-17
l x b x h,



Placenta Pan
SLD-23-130-36
Size 1,

Sterilization



Waste Cotton Collector
SLD-23-131-01
? 50 mm x 75 mm,



Spirit Lamp
SLD-23-132-07
120 ccm,

